



METALÚRGICA
ED-MIA S.R.L



Nuevo catálogo de
PRODUCTOS

Nuestros productos



TRANSMISIONES
CARDÁNICAS



HORQUILLAS



LIMITADORES DE
POTENCIA



JUNTAS
HOMOCINÉTICAS



ACCESORIOS DE
TRANSMISIÓN

ACCESORIOS DE TRANSMISIÓN

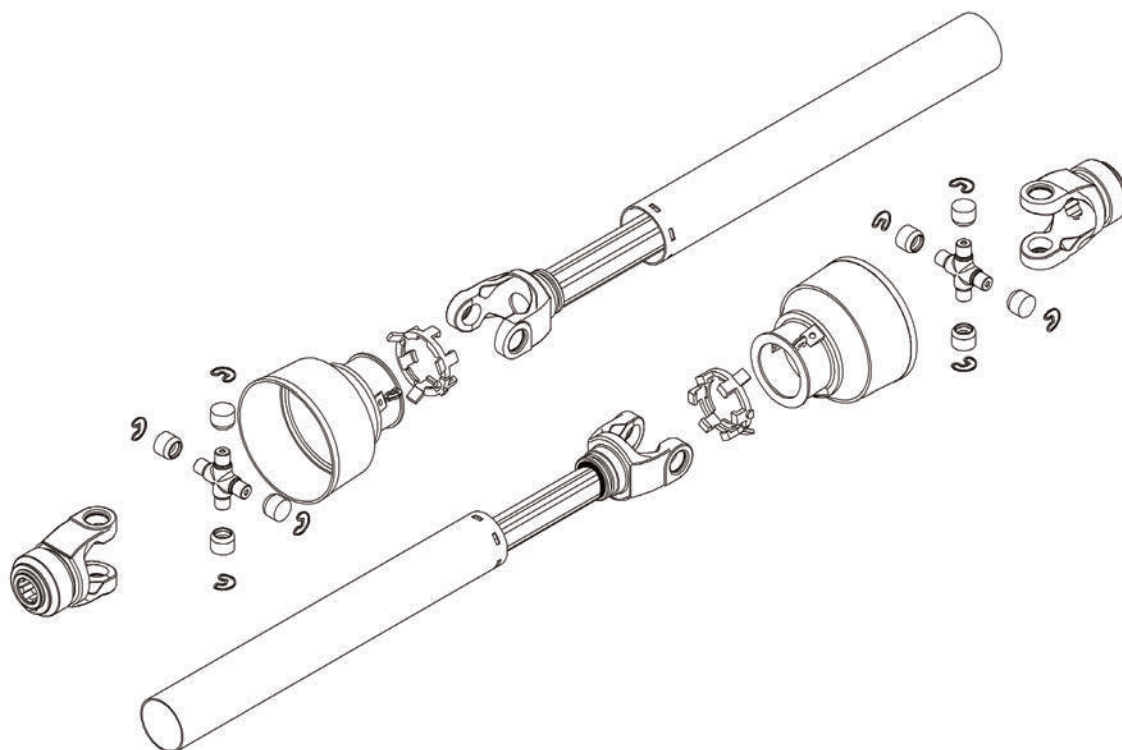

- BUJES CUADRADOS
- BUJES ESTRIADOS LISOS
- BUJES ESTRIADOS PARTIDO
- PUNTAS ESTRIADAS
- EJES CUADRADOS
- PROLONGACIONES
- REPUESTOS DE SEGURO A BOLITAS
- FERRODOS
- BLINDAJES
- REPUESTOS LIMITADORES DE POTENCIA
- MOVIMIENTOS ESPECIALES
- JUNTA HOMOCINÉTICA
- RUEDA LIBRE
- CRUCETAS
- LIMITADORES DE POTENCIA
- CAÑO C/BUJE, OVOIDAL, TRILOBULAR Y CUADROLOBULAR



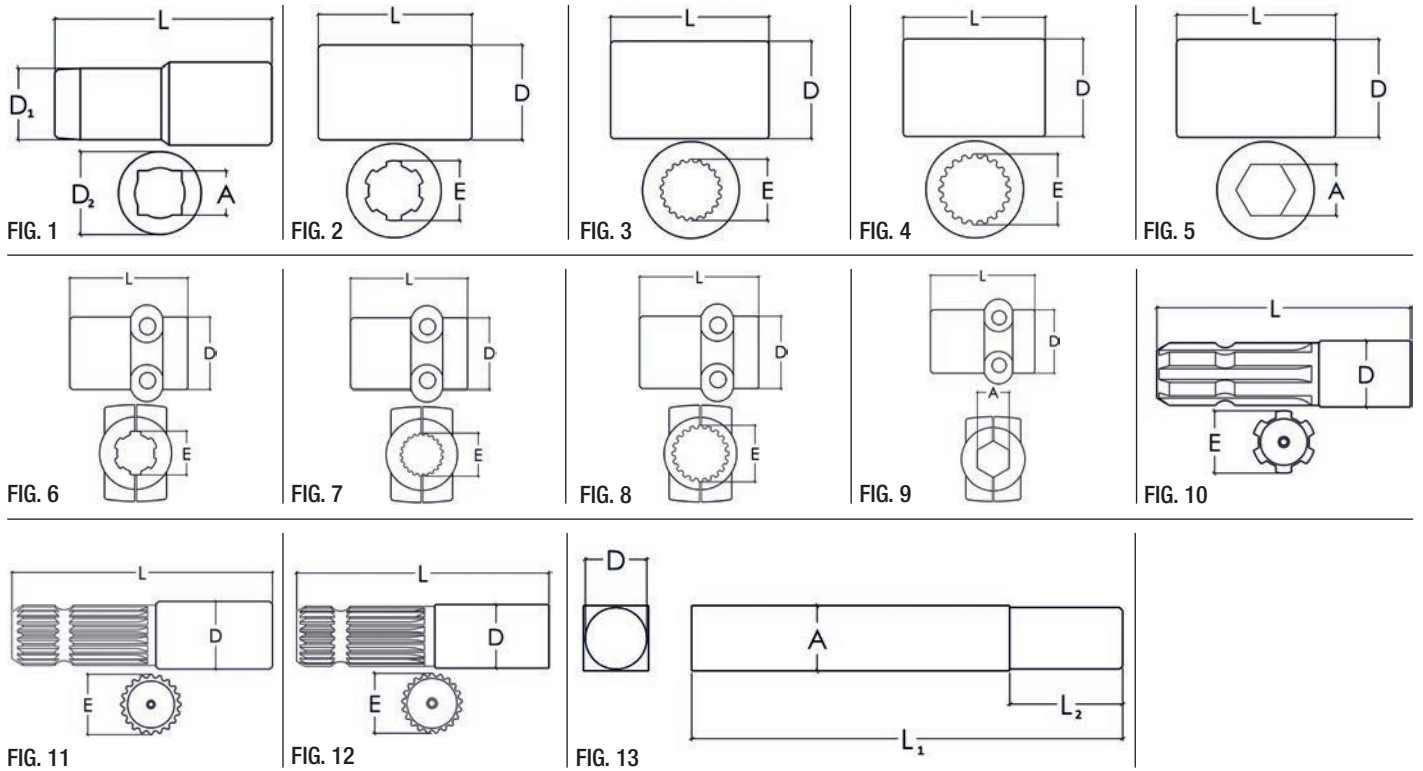

BUJES, PUNTAS ESTRIADAS Y EJES CUADRADOS

FIG.	DESCRIPCIÓN	CÓDIGO	PRECIO
1	BUJE INT. CUADRADO K526 (D1=36.4mm) (D2=42mm) (L=110mm) (A=7/8")	A-2000	
1	BUJE INT. CUADRADO K521 (D1=42.5mm) (D2=43.25mm) (L=111mm) (A=1")	A-2001	
1	BUJE INT. CUADRADO K518 (D1=53.7mm) (D2=55mm) (L=110mm) (A=1 1/4")	A-2002	
2	BUJE INTERIOR (L=90mm) (D=55mm) (E=6 1 3/8")	A-2003	
2	BUJE INTERIOR (L=90mm) (D=55mm) (E=6 1 3/8") C/TRAT. TÉRMICO	A-2003/1	
2	BUJE INTERIOR (L=90mm) (D=62mm) (E=6 1 3/4")	A-2003/3	
3	BUJE INTERIOR (L=90mm) (D=55mm) (E=21 1 3/8")	A-2003/2	
4	BUJE INTERIOR (L=90mm) (D=62mm) (E=20 1 3/4")	A-2003/4	
5	BUJE INTERIOR HEXAGONAL (L=90mm) (D=55mm) (A=1 1/8")	A-2036	
6	BUJE ESTRIADO PARTIDO (D=58mm) (L=95mm) (E=6 1 3/8")	A-2006	
6	BUJE ESTRIADO PARTIDO (D=58mm) (L=95mm) (E=6 1 3/4")	A-2006/1	
7	BUJE ESTRIADO PARTIDO (D=58mm) (L=95mm) (E=21 1 3/8")	A-2006/2	
8	BUJE ESTRIADO PARTIDO (D=58mm) (L=95mm) (E=20 1 3/4")	A-2006/3	
9	BUJE HEXAGONAL PARTIDO (D=58mm) (A=1 1/8") (L=95mm)	A-2036/1	
10	PUNTA ESTRIADA (L=150mm) (D=36.6mm) (E=6 1 3/8")	A-2004	
10	PUNTA ESTRIADA (L=150mm) (D=36.6mm) (E=6 1 3/8") C/TRAT. TÉRMICO	A-2004/1	
10	PUNTA ESTRIADA (L=300mm) (D=36mm) (E=6 1 3/8")	A-2005	
10	PUNTA ESTRIADA (L=300mm) (D=36mm) (E=6 1 3/8") C/TRAT. TÉRMICO	A-2005/1	
10	PUNTA ESTRIADA (L=500mm) (D=49.5mm) (E=6 1 3/8")	A-2005/2	
10	PUNTA ESTRIADA (L=500mm) (D=49.5mm) (E=6 1 3/8") C/TRAT. TÉRMICO	A-2005/10	
10	PUNTA ESTRIADA (L=300mm) (D=49.5mm) (E=6 1 3/4")	A-2005/3	
10	PUNTA ESTRIADA (L=400mm) (D=36.6mm) (E=6 1 3/8")	A-2005/8	
10	PUNTA ESTRIADA (L=400mm) (D=36.6mm) (E=6 1 3/8") C/TRAT. TÉRMICO	A-2005/9	
11	PUNTA ESTRIADA (L=300mm) (D=49.5mm) (E=20 1 3/4")	A-2005/6	
12	PUNTA ESTRIADA (L=150mm) (D=37mm) (E=21 1 3/8")	A-2005/7	
12	PUNTA ESTRIADA (L=150mm) (D=37mm) (E=21 1 3/8") C/TRAT. TÉRMICO	A-2005/5	
12	PUNTA ESTRIADA (L=300mm) (D=36.8mm) (E=21 1 3/8")	A-2005/4	
12	PUNTA ESTRIADA (L=300mm) (D=36.8mm) (E=21 1 3/8") C/TRAT. TÉRMICO	A-2005/11	
13	EJE CUADRADO K526 (L1=650mm) (L2=27.5mm) (D=22mm) (A= 7/8")	A2016	
13	EJE CUADRADO K521 (L1=700mm) (L2=56mm) (D=25mm) (A=1")	A-2017	
13	EJE CUADRADO K518 - K514 (L1=700mm) (L2=55mm) (D=30mm) (A=1 1/4")	A-2018	

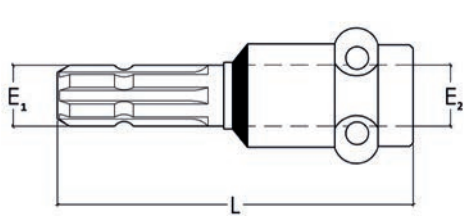

FIG. 1

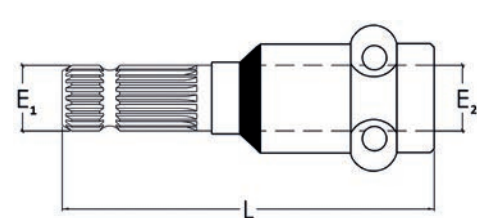

FIG. 2



FIG. 3

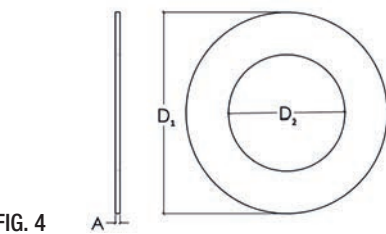

FIG. 4

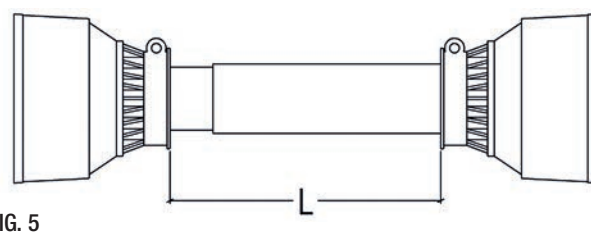

FIG. 5

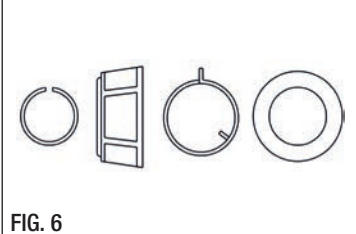

FIG. 6

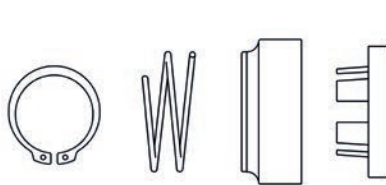

FIG. 7

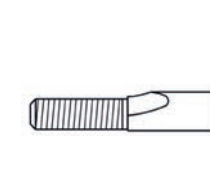

FIG. 8

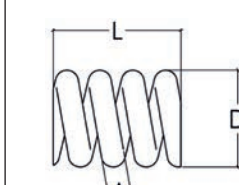

FIG. 9

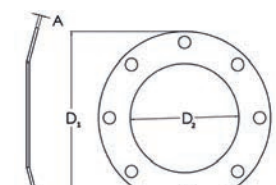
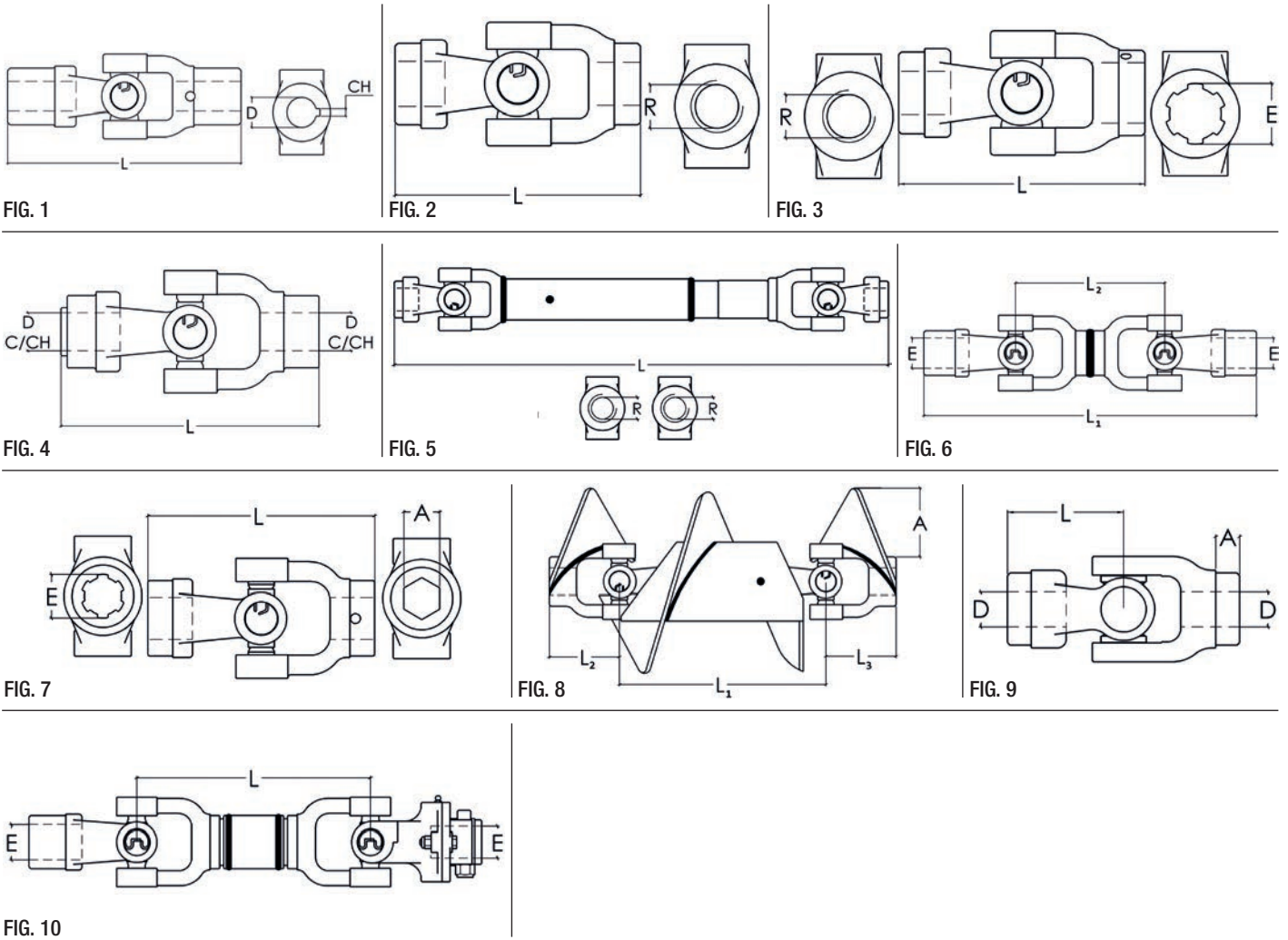

FIG. 10

PROLONGACIONES, FERRODOS, REPUESTOS Y BLINDAJES

FIG.	DESCRIPCIÓN	CÓDIGO	PRECIO
1	PROLONGACIÓN MACHO (E1=6 1 3/8") HEMBRA (E2=6 1 3/8") (L=204mm)	A-2020	
1	PROLONGACIÓN MACHO (E1=6 1 3/8") HEMBRA (E2=21 1 3/8") (L=204mm)	A-2020/1	
1	PROLONGACIÓN MACHO (E1=6 1 3/8") HEMBRA (E2=6 1 3/4") (L=199mm)	A-2020/2	
1	PROLONGACIÓN MACHO (E1=6 1 3/8") HEMBRA (E2=20 1 3/4") (L=203mm)	A-2020/3	
2	PROLONGACIÓN MACHO (E1=21 1 3/8") HEMBRA (E2=6 1 3/4") (L=199mm)	A-2020/4	
2	PROLONGACIÓN MACHO (E1=21 1 3/8") HEMBRA (E2=6 1 3/8") (L=189mm)	A-2020/5	
2	PROLONGACIÓN MACHO (E1=6 1 3/8") HEMBRA (HEX. 1 1/8") (L=189mm)	A-2020/6	
2	PROLONGACIÓN MACHO (E1=21 1 3/8") HEMBRA (HEX. 1 1/8") (L=189mm)	A-2020/7	
3	REPUESTO PARA SEGURO BOTÓN K518 - K521	A-2029	
3	REPUESTO PARA SEGURO A BOTÓN K526	A-2029/1	
4	FERRODO PARA ZAFE SIMPLE Y MÚLTIPLE K518 - K514 - Nº8 (D1=151mm) (D2=87.2mm) (A=4mm)	A-2014	
4	FERRODO PARA ZAFE MUL. Y RUEDA LIBRE (D1=160mm) (D2=101mm) (A=4mm)	A-2014/1	
5	BLINDAJE COMPLETO K526 (L=1500mm)	A-2012	
5	BLINDAJE COMPLETO K521 K518 K514 (L=1500mm)	A-2013	
6	REPUESTO PARA SEGURO A BOLITAS K526	A-2010	
6	REPUESTO PARA SEGURO A BOLITAS 6 ESTRIAS 1 3/8" K518 - K514 - K521 - Nº8	A-2011	
7	REPUESTO PARA SEGURO A BOLITAS 6 ESTRIAS 1 3/8" K518 - K514 - K521 - Nº8 (NYLON)	A-2011/1	
8	PERNO DE AJUSTE DE ESTRIAS	A-2021	
9	RESORTE PARA ZAFES (L=33mm) (A=6mm) (D=25mm)	A-2015	
10	ARANDELA CÓNCAVA PARA ZAFE A DIAF. MÚL Y SIM. (D1=188mm) (D2=164mm) (A=3mm)	A-2022	
10	ARANDELA CÓNCAVA PARA ZAFE MÚL. C/RUEDA LIBRE (D1=200mm) (D2=128mm) (A=3mm)	A-2023	



MOVIMIENTOS ESPECIALES

FIG.	DESCRIPCIÓN	CÓDIGO	PRECIO
1	MOVIMIENTO BERNARDIN M-19 (D=27mm) (CH=8X4) (L=197.84mm)	M-5000	
2	MOVIMIENTO VASSALLI 900 (D=1" ROSCA W DERECHA) AMBOS LADOS (L=141.84mm)	M-5002	
2	MOVIMIENTO VASSALLI 900 (D=1" ROSCA W IZQUIERDA) AMBOS LADOS (L=141.84mm)	M-5003	
3	MOVIMIENTO VASSALLI 1200 (D=1" ROSCA W DERECHA) (E=6 1 3/8") (L=141.84mm)	M-5004	
3	MOVIMIENTO DON ROQUE (D= 1 1/4" ROSCA W DERECHA) (E=6 1 3/8") (L=141.84mm)	M-5006	
3	MOVIMIENTO DON ROQUE (D= 1 1/8" ROSCA W DERECHA) (E=6 1 3/8") (L=141.84mm)	M-5007	
3	MOVIMIENTO DANIELE (D=7/8" ROSCA W DERECHA) (E= 6 1 3/8") (L=141.84mm)	M-5008	
4	MOVIMIENTO DEUTZ OPTIMA K521 (D=30mm) (CH=8X4) C/GUÍA (L=204.78mm)	M-5009	
5	MOVIMIENTO BERNARDIN M-23 (D=ROSCA NF 1 1/8") EN AMBOS LADOS (L=565mm)	M-5001	
6	MOVIMIENTO YOMEL K518 INT (E=6 1 3/8") AMBOS LADOS (L1=444.36mm) (L2=199.18mm) (D3=30.18mm)	M-5010	
7	MOVIMIENTO JOHN DEERE K521 (E=6 1 3/8") (A=1 1/8") (L=183mm)	M-5011	
8	MOVIMIENTO NEW HOLLAND TC 57 (L1=284mm) (L2=90mm) (L3=90mm) (A=80mm)	M-5012	
9	MOVIMIENTO K530 (D=19mm) LISA X 2 (L=63mm) (A=13mm)	M-5013	
10	MOVIMIENTO YOMEL C/ZAFE A FUSIBLE (E=6 1 3/8") (L=265.45mm)	M-5014	

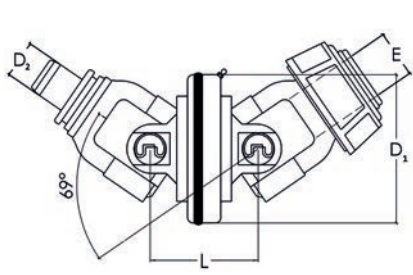

FIG. 1

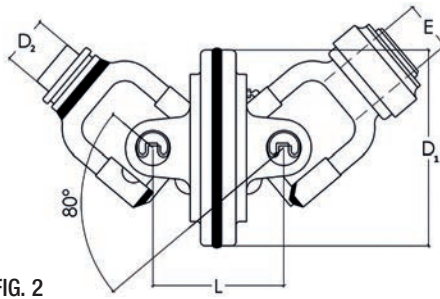

FIG. 2

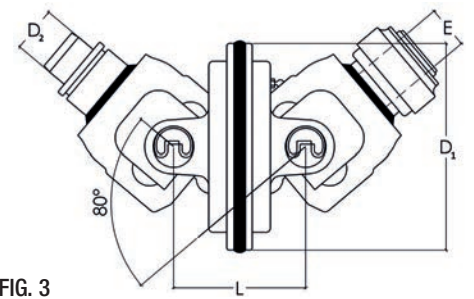

FIG. 3

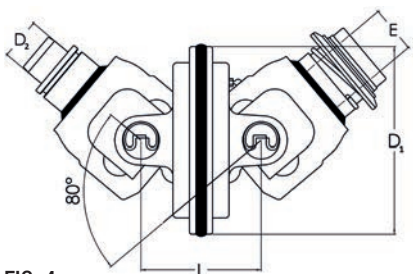

FIG. 4

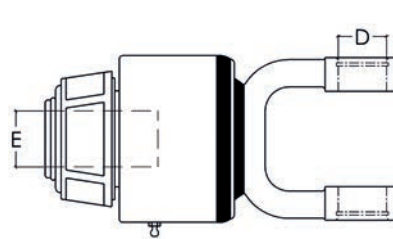

FIG. 5

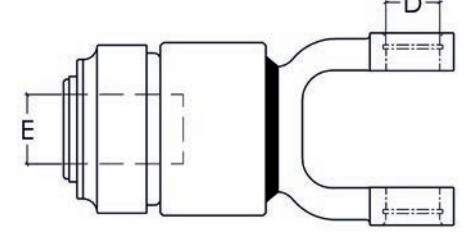

FIG. 6

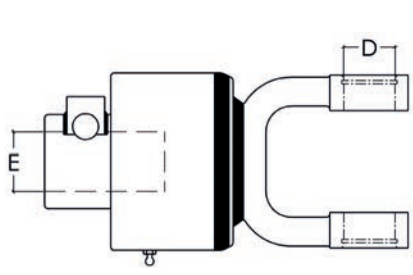

FIG. 7

JUNTA HOMOCINÉTICA Y RUEDA LIBRE

FIG.	DESCRIPCIÓN	CÓDIGO	PRECIO
1	JUNTA HOM. K526 S/BOL. (E=6 1 3/8") Y HORQ. P/CAÑO TRI. HEMBRA (L=80.7mm) (D1=110mm) (D2=27.7mm)	J-6000	
2	JUNTA HOM. K518 S/BOL. (E=6 1 3/8") Y HORQ. P/CAÑO TRI. HEMBRA (L=114.54mm) (D1=171mm) (D2=41.5mm)	J-8000	
3	JUNTA HOM. K512 S/BOL. (E=6 1 3/8") P/CAÑO CUADROLOB. HEMBRA (L=121mm) (D1=193.25mm) (D2=42.4mm)	J-2000	
3	JUNTA HOM. K512 S/BOL. (E=21 1 3/8") P/CAÑO CUADROLOB. HEMBRA (L=121mm) (D1=193.25mm) (D2=42.4mm)	J-2000/1	
4	JUNTA HOM. K512 S/BOL. (E=6 1 3/4") P/CAÑO CUADROLOB. HEMBRA (L=121mm) (D1=193.25mm) (D2=42.4mm)	J-2000/2	
4	JUNTA HOM. K512 S/BOL. (E=20 1 3/4") P/CAÑO CUADROLOB. HEMBRA (L=121mm) (D1=193.25mm) (D2=42.4mm)	J-2000/3	
5	RUEDA LIBRE A PESTILLO K518 S/BOL. (E=6 1 3/8") (D=30.18mm)	RLP-8000	
5	RUEDA LIBRE A PESTILLO K514 S/BOL. (E=6 1 3/8") (D=38.06mm)	RLP-4000	
6	RUEDA LIBRE A RODILLO K521 S/BOL. (E=6 1 3/8") (D=27.00mm)	RLR-1000	
6	RUEDA LIBRE A RODILLO K526 S/BOL. (E=6 1 3/8") 1 3/8" (D=23.84mm)	RLR-6000	
7	RUEDA LIBRE A PESTILLO K514 S/BOL. (E=6 1 3/8") (D=38.06mm)	RLR-4000/1	
7	RUEDA LIBRE A PESTILLO K518 S/BOL. (E=6 1 3/8") (D=30.18mm)	RLR-8000/1	

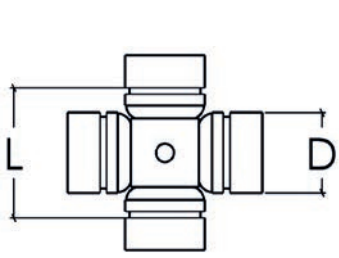

FIG. 1

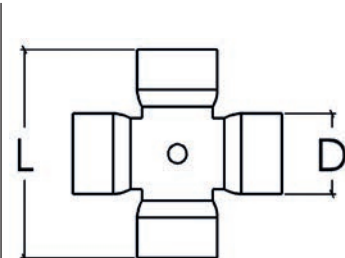

FIG. 2

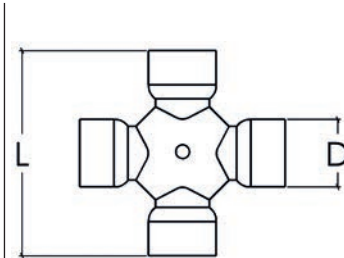

FIG. 3

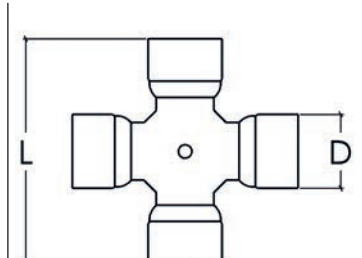

FIG. 4

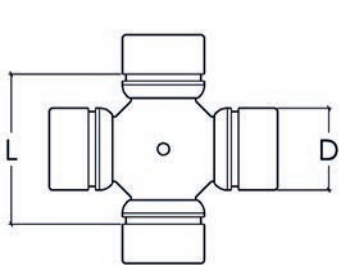

FIG. 5

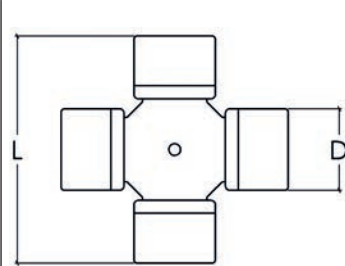

FIG. 6

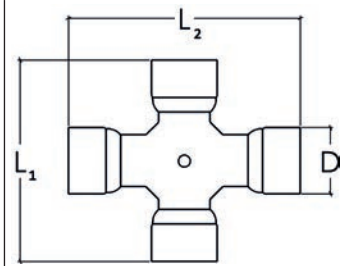

FIG. 7

CRUCETAS MEM

FIG.	DESCRIPCIÓN	CÓDIGO	PRECIO
1	CRUZ Y DADO K530 A BUJE MEM (D=24.6mm) (L=36.8mm)	A-2041	
2	CRUZ Y DADO K526 A PALILLOS MEM (D=23.85mm) (L=61.6mm)	A-2007	
2	CRUZ Y DADO K526 A BUJE MEM (D=23.85mm) (L=61.6mm)	A-2007/1	
3	CRUZ Y DADO K521 A PALILLOS MEM (D=27mm) (L=81.9mm)	A-2008	
3	CRUZ Y DADO K521 A BUJE MEM (D=27mm) (L=81.9mm)	A-2008/1	
4	CRUZ Y DADO K518 A PALILLOS MEM (D=30.18mm) (L=92mm)	A-2009	
4	CRUZ Y DADO K518 A BUJE MEM (D=30.18mm) (L=92mm)	A-2009/1	
5	CRUZ Y DADO K514 A PALILLOS MEM (D=38.06mm) (L=63.7mm)	A-2019	
6	CRUZ Y DADO K512 A PALILLOS (D=38.06mm) (L=106mm)	A-2042	
7	CRUZ Y DADO P/JUNTA HOMOCINÉTICA K518 MEM (L1=106.1mm) (L2=92mm) (D=30.18mm)	A-2021	

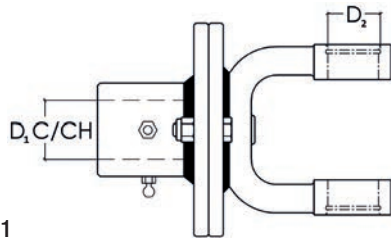

FIG. 1

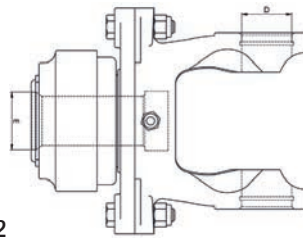

FIG. 2

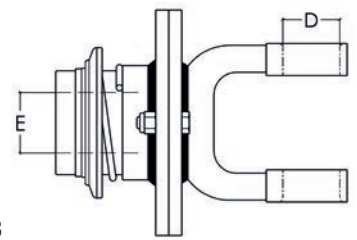

FIG. 3

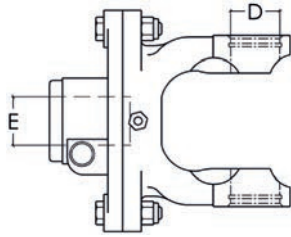

FIG. 4

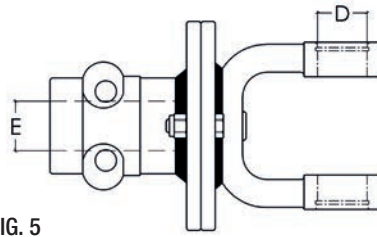

FIG. 5

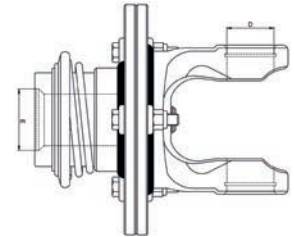

FIG. 6

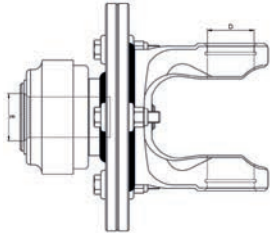

FIG. 7

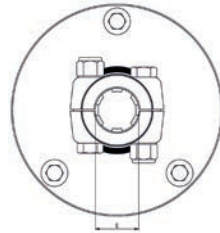
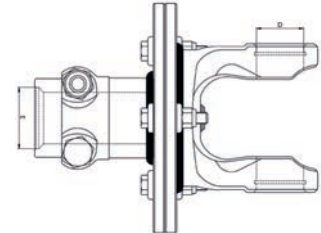

FIG. 8



LIMITADORES DE POTENCIA A FUSIBLE

FIG.	DESCRIPCIÓN	CÓDIGO	PRECIO
1	ZAFE A FUSIBLE (D=35mm) (CH=8X4) HORQ. K514 (D2=38.06mm)	ZF-0003/1	
1	ZAFE A FUSIBLE (D=35mm) (CH=8X4mm) HORQ. K518 (D2=30.18mm)	ZF-0003	
1	ZAFE A FUSIBLE (D=35mm) (CH=8X4) HORQ. K521 (D2=27.00mm)	ZF-0003/2	
1	ZAFE A FUSIBLE (D=44.70mm) (CH=10X5mm) HORQ. K518 (D=30.18mm)	ZF-0007	
2	ZAFE A FUSIBLE S/BOL. (E=6 1 3/8") HORQ. K526 (D=23.84mm)	ZF-0008/5	
2	ZAFE A FUSIBLE S/BOL. (E=6 1 3/8") HORQ. K521 (D=27mm)	ZF-0008/3	
2	ZAFE A FUSIBLE S/BOL. (E=6 1 3/8") HORQ. K518 (D=30.18mm)	ZF-0008	
2	ZAFE A FUSIBLE S/BOL. (E=6 1 3/8") HORQ. K514 (D=38.06mm)	ZF-0008/1	
3	ZAFE A FUSIBLE S/BOL. (E=20 1 3/4") HORQ. K514 (D=38.06mm)	ZF-0008/2	
3	ZAFE A FUSIBLE S/BOL. (E=6 1 3/4") HORQ. K514 (D=38.06mm)	ZF-0008/4	
4	ZAFE A FUSIBLE S/BULÓN (E=6 1 3/8") HORQ. K518 (D=30.18mm)	ZF-0008/6	
5	ZAFE A FUSIBLE C/BUJE PARTIDO (E=6 1 3/8") HORQ. K526 (D=23.84mm)	ZF-0004/3	
5	ZAFE A FUSIBLE C/BUJE PARTIDO (E=6 1 3/8") HORQ. K521 (D=27mm)	ZF-0004/2	
5	ZAFE A FUSIBLE C/BUJE PARTIDO (E=6 1 3/8") HORQ. K518 (D=30.18mm)	ZF-0004	
5	ZAFE A FUSIBLE C/BUJE PARTIDO (E=6 1 3/4") HORQ. K518 (D=30.18mm)	ZF-0004/4	
5	ZAFE A FUSIBLE C/BUJE PARTIDO (E=20 1 3/4") HORQ. K518 (D=30.18mm)	ZF-0004/5	
5	ZAFE A FUSIBLE C/BUJE PARTIDO (E=6 1 3/8") HORQ. K514 (D=38.06mm)	ZF-0004/1	
5	ZAFE A FUSIBLE C/BUJE PARTIDO (E=6 1 3/4") HORQ. K514 (D=38.06mm)	ZF-0004/6	
5	ZAFE A FUSIBLE C/BUJE PARTIDO (E=20 1 3/4") HORQ. K514 (D=38.06mm)	ZF-0004/7	
6	ZAFE A FUSIBLE S/BOL. (E=6 1 3/4") HORQ. N°8 (D=34.98mm)	ZF-0009	
7	ZAFE A FUSIBLE S/BOL. (E=6 1 3/8") HORQ. N°8 (D=34.98mm)	ZF-0010	
8	ZAFE A FUSIBLE C/BUJE PARTIDO (E=6 1 3/8") HORQ. N°8 (D=34.98mm)	ZF-0011	

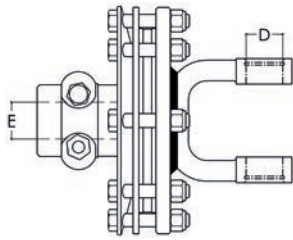

FIG. 1

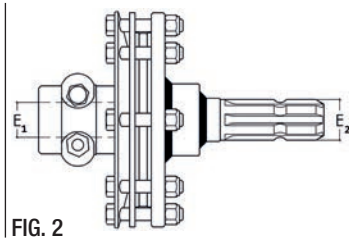

FIG. 2

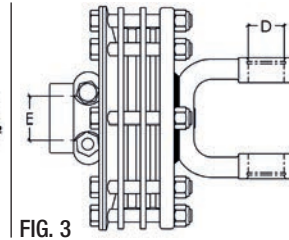

FIG. 3

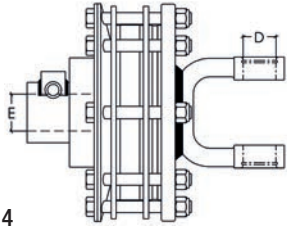
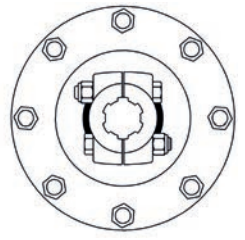

FIG. 4

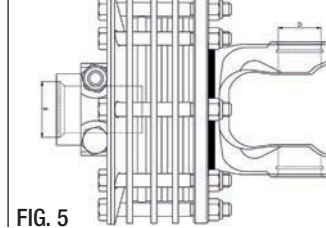
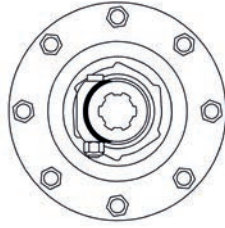

FIG. 5

LIMITADORES DE POTENCIA A FERRODO

FIG.	DESCRIPCIÓN	CÓDIGO	PRECIO
1	ZAFE SIMPLE A DIAFRAGMA BUJE PARTIDO (E=6 1 3/8") HORQ. K521 (D=27.00mm)	ZS-0001/1	
1	ZAFE SIMPLE DE A DIAFRAGMA BUJE PARTIDO (E=6 1 3/8") HORQ. K518 (D=30.18mm)	ZS-0001	
2	ZAFE SIMPLE A DIAFRAGMA BUJE PARTIDO (E1=6 1 3/8") PUNTA (E2=6 1 3/8")	ZS-0011	
3	ZAFE MULTIPLE A DIAFRAGMA BUJE PARTIDO (E=6 1 3/8") HORQ. K514 (D=38.06mm)	ZM-0009	
3	ZAFE MULTIPLE A DIAFRAGMA BUJE PARTIDO (E=6 1 3/4") HORQ. K514 (D=38.06mm)	ZM-0014	
3	ZAFE MULTIPLE A DIAFRAGMA BUJE PARTIDO (E=6 1 3/8") HORQ. K518 (D=30.18mm)	ZM-0010	
3	ZAFE MULTIPLE A DIAFRAGMA BUJE PARTIDO (E=6 1 3/4") HORQ. K518 (D=30.18mm)	ZM-0015	
4	ZAFE MULTIPLE A DIAFRAGMA C/R LIBRE A PESTILLO (E=6 1 3/8") K518 (D=30.18mm)	ZML-0012	
4	ZAFE MULTIPLE A DIAFRAGMA C/R LIBRE A PESTILLO (E=6 1 3/8") K514 (D=38.06mm)	ZML-0013	
5	ZAFE MULTIPLE A DIAFRAGMA BUJE PARTIDO (E=6 1 3/8") HORQ. Nº8 (D=34.98mm)	ZM-0001	

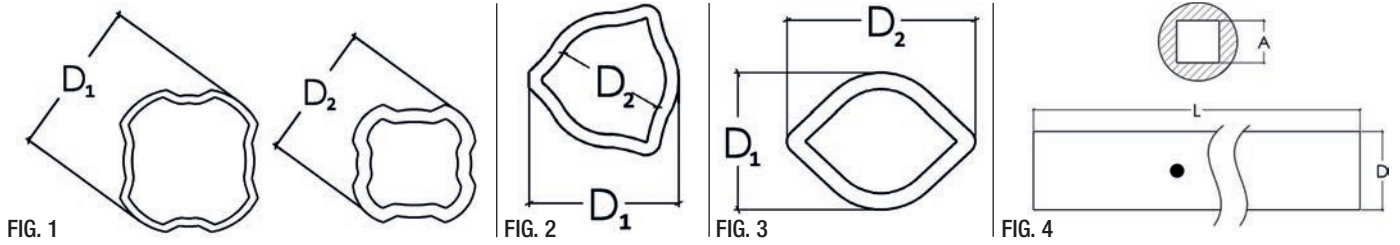
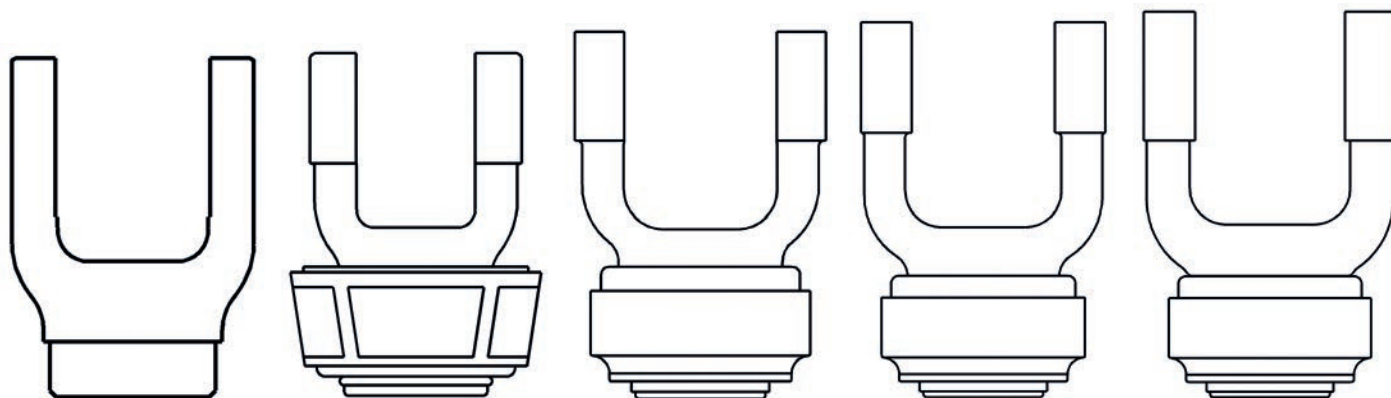
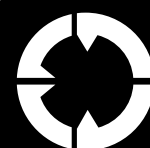

FIG.	DESCRIPCIÓN	CÓDIGO	PRECIO
CAÑO CUADROLOBULAR			
1	CAÑO CUADROLOBULAR MACHO (D=51.5mm) (L=500mm)	CC-40010	
	AGREGAR CADA 100mm	CC-40010/1	
1	CAÑO CUADROLOBULAR HEMBRA (D=58.3mm) (L=500mm)	CC-40140	
	AGREGAR CADA 100mm	CC-40140/1	
CAÑO TRILOBULAR			
2	CAÑO TRILOBULAR K514 MACHO (L=500mm) (D1=45mm) (D2=30.20mm)	CT-40010	
	AGREGAR CADA 100mm	CT-40010/1	
2	CAÑO TRILOBULAR K514 HEMBRA (L=500mm) (D1=53.6mm) (D2=41.70mm)	CT-40140	
	AGREGAR CADA 100mm	CT-40140/1	
2	CAÑO TRILOBULAR K518 MACHO (L=500mm) (D1=45mm) (D2=33.20mm)	CT-80010	
	AGREGAR CADA 100mm	CT-80010/1	
2	CAÑO TRILOBULAR K518 HEMBRA (L=500mm) (D1=52mm) (D2=41.70mm)	CT-80140	
	AGREGAR CADA 100mm	CT-80140/1	
2	CAÑO TRILOBULAR K521 MACHO (L=500mm) (D1=36mm) (D2=27.60mm)	CT-10010	
	AGREGAR CADA 100mm	CT-10010/1	
2	CAÑO TRILOBULAR K521 HEMBRA (L=500mm) (D1=44mm) (D2=34.00mm)	CT-10140	
	AGREGAR CADA 100mm	CT-10140/1	
2	CAÑO TRILOBULAR K526 MACHO (L=500mm) (D1=29mm) (D2=20.30mm)	CT-60010	
	AGREGAR CADA 100mm	CT-60010/1	
2	CAÑO TRILOBULAR K526 HEMBRA (L=500mm) (D1=37mm) (D2=27.60mm)	CT-60140	
	AGREGAR CADA 100mm	CT-60140/1	
CAÑO OVOIDAL			
3	CAÑO OVOIDAL K518 MACHO (L=500mm) (D1=43.5mm) (D2=51.9mm)	CO-80010	
	AGREGAR CADA 100mm	CO-80010/1	
3	CAÑO OVOIDAL K518 HEMBRA (L=500mm) (D1=52mm) (D2=67mm)	CO-80140	
	AGREGAR CADA 100mm	CO-80140/1	
3	CAÑO OVOIDAL K521 MACHO (L=500mm) (D1=36.5mm) (D2=46.7mm)	CO-10010	
	AGREGAR CADA 100mm	CO-10010/1	
3	CAÑO OVOIDAL K521 HEMBRA (L=500mm) (D1=43mm) (D2=54.4mm)	CO-10140	
	AGREGAR CADA 100mm	CO-10140/1	
3	CAÑO OVOIDAL K526 MACHO (L=500mm) (D1=30.5mm) (D2=36.8mm)	CO-60010	
	AGREGAR CADA 100mm	CO-60010/1	
3	CAÑO OVOIDAL K526 HEMBRA (L=500mm) (D1=37mm) (D2=54.4mm)	CO-60140	
	AGREGAR CADA 100mm	CO-60140/1	
CAÑO CON BUJE CUADRADO			
4	CAÑO C/BUJE CUADRADO (L=500mm) (A=1 1/4") (D=60.3mm) K518 - K514	C-3028	
	AGREGAR CADA 100mm	C-3028/1	
4	CAÑO C/BUJE CUADRADO (L=500mm) (A=1") (D=48.3mm) K521	C-3016	
	AGREGAR CADA 100mm	C-3016/1	
4	CAÑO C/BUJE CUADRADO (L=500mm) (A=7/8") (D=42.4mm) K526	C-3004	
	AGREGAR CADA 100mm	C-3004/1	

LÍNEA HORQUILLAS FORJADAS



- MEDIAS BARRAS
- TRANSMISIONES CARDÁNICAS CON CAÑO REDONDO C/ BUJE CUADRADO (K514 - K518- K521 - K526)
- TRANSMISIONES CARDÁNICAS CON CAÑO TRILOBULAR (K514 - K518- K521 - K526)
- TRANSMISIONES CARDÁNICAS CON CAÑO OVOIDAL (K518- K521 - K526)
- CAÑOS CON HORQUILLAS SOLDADAS (K514 - K518 -K521 - K526)
- HORQUILLAS K530
- HORQUILLAS K526
- HORQUILLAS K521
- HORQUILLAS K518
- HORQUILLAS K514



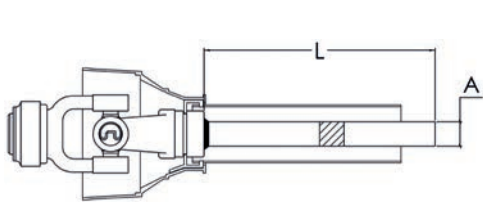

FIG. 1

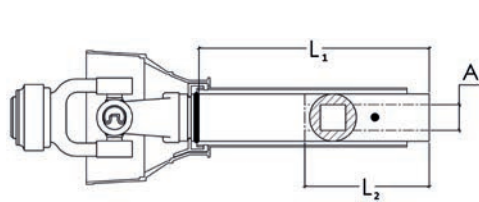

FIG. 2

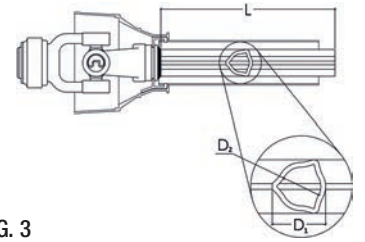

FIG. 3

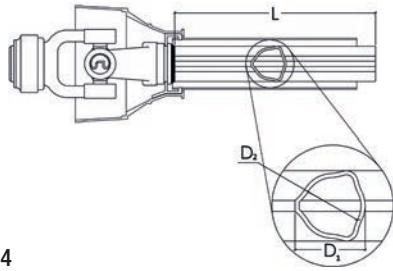

FIG. 4

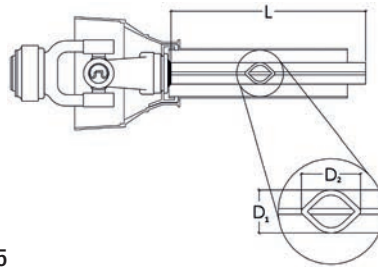

FIG. 5

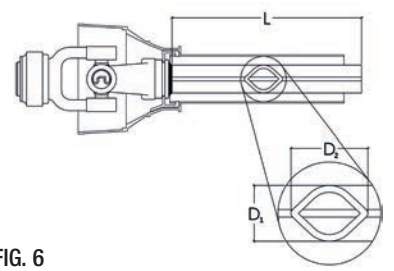

FIG. 6

FIG.	DESCRIPCIÓN	CÓDIGO	PRECIO
MEDIA BARRA L/EJE CUADRADO			
1	1/2 BARRA K526 L/EJE CUAD. S/BOL. (L=700mm) (A=7/8") BLIND.	MBEH-0500	
1	1/2 BARRA K521 L/EJE CUAD. S/BOL. (L=700mm) (A=1") BLIND.	MBEH-0600	
1	1/2 BARRA K518 L/EJE CUAD. S/BOL. (L=700mm) (A=1 1/4") BLIND.	MBEH-0700	
1	1/2 BARRA K514 L/EJE CUAD. S/BOL. (L=700mm) (A=1 1/4") BLIND.	MBEH-0800	
MEDIA BARRA L/CAÑO CON BUJE			
2	1/2 BARRA K526 L/CAÑO C/BUJE CUAD. S/BOL. (L1=500mm) (A=7/8") (L2=110MM) BLIND. AGREGAR CADA 100mm	MBCH-0500 MBCH-0500/1	
2	1/2 BARRA K521 L/CAÑO C/BUJE CUAD. S/BOL. (L1=500mm) (A=1") (L2=111MM) BLIND. AGREGAR CADA 100mm	MBCH-0600 MBCH-0600/1	
2	1/2 BARRA K518 L/CAÑO C/BUJE CUAD. S/BOL. (L1=500mm) (A=1 1/4") (L2=110MM) BLIND. AGREGAR CADA 100mm	MBCH-0700 MBCH-0700/1	
2	1/2 BARRA K514 L/CAÑO C/BUJE CUAD. S/BOL. (L1=500mm) (A=1 1/4") (L2=110MM) BLIND. AGREGAR CADA 100mm	MBCH-0800 MBCH-0800/1	
MEDIA BARRA TRILOBULAR MACHO			
3	1/2 BARRA K526 TRI. MACHO S/BOL. (L=900mm) (D1=29mm) (D2=20.30mm) BLIND.	MBMTH-0500	
3	1/2 BARRA K521 TRI. MACHO S/BOL. (L=900mm) (D1=36mm) (D2=27.60mm) BLIND.	MBMTH-0600	
3	1/2 BARRA K518 TRI. MACHO S/BOL. (L=900mm) (D1=45mm) (D2=33.20mm) BLIND.	MBMTH-0700	
3	1/2 BARRA K514 TRI. MACHO S/BOL. (L=900mm) (D1=45mm) (D2=30.20mm) BLIND.	MBMTH-0800	
MEDIA BARRA TRILOBULAR HEMBRA			
4	1/2 BARRA K526 TRI. HEMBRA S/BOL. (L=500mm) (D1=37mm) (D2=27.60mm) BLIND. AGREGAR CADA 100mm	MBHTH-0500 MBHTH-0500/1	
4	1/2 BARRA K521 TRI. HEMBRA S/BOL. (L=500mm) (D1=44mm) (D2=34mm) BLIND. AGREGAR CADA 100mm	MBHTH-0600 MBHTH-0600/1	
4	1/2 BARRA K518 TRI. HEMBRA S/BOL. (L=500mm) (D1=52mm) (D2=41.7mm) BLIND. AGREGAR CADA 100mm	MBHTH-0700 MBHTH-0700/1	
4	1/2 BARRA K514 TRI. HEMBRA S/BOL. (L=500mm) (D1=53.6mm) (D2=41.70mm) BLIND. AGREGAR CADA 100mm	MBHTH-0800 MBHTH-0800/1	
MEDIA BARRA OVOIDAL MACHO			
5	1/2 BARRA K526 OV. MACHO S/BOL. (L=900mm) (D1=30.5mm) (D2=36.8mm) BLIND.	MBMOH-0500	
5	1/2 BARRA K521 OV. MACHO S/BOL. (D1=36.5mm) (D2=46.7mm) (L=900mm) BLIND.	MBMOH-0600	
5	1/2 BARRA K518 OV. MACHO S/BOL. (L=900mm) (D1=43.5mm) (D2=51.9mm) BLIND.	MBMOH-0700	
MEDIA BARRA OVOIDAL HEMBRA			
6	1/2 BARRA K526 OV. HEMBRA S/BOL. (L=500mm) (D1=37mm) (D2=54.4mm) BLIND. AGREGAR CADA 100mm	MBHOH-0500 MBHOH-0500/1	
6	1/2 BARRA K521 OV. HEMBRA S/BOL. (L=500mm) (D1=43mm) (D2=54.4mm) BLIND. AGREGAR CADA 100mm	MBHOH-0600 MBHOH-0600/1	
6	1/2 BARRA K518 OV. HEMBRA S/BOL. (L=500mm) (D1=52mm) (D2=67mm) BLIND. AGREGAR CADA 100mm	MBHOH-0700 MBHOH-0700/1	

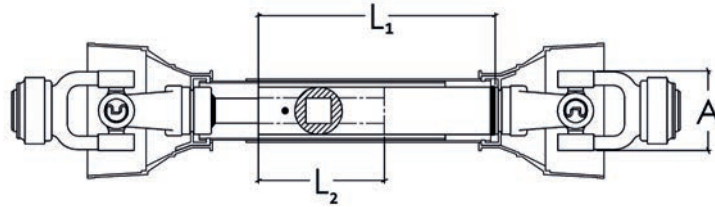

FIG. 1

BARRA K526 BLINDADA C/CAÑO REDONDO SEGURO A BOLITAS X 2 C/HORQ. FORJADA

FIG.	DESCRIPCIÓN	CÓDIGO	PRECIO
1	(L=500mm) (L2=300mm) (A=71.50mm)	BH-6100	
1	(L=600mm) (L2=300mm) (A=71.50mm)	BH-6101	
1	(L=700mm) (L2=300mm) (A=71.50mm)	BH-6102	
1	(L=800mm) (L2=300mm) (A=71.50mm)	BH-6103	
1	(L=900mm) (L2=300mm) (A=71.50mm)	BH-6104	
1	(L=1000mm) (L2=300mm) (A=71.50mm)	BH-6105	
1	(L=1100mm) (L2=300mm) (A=71.50mm)	BH-6106	
1	(L=1200mm) (L2=300mm) (A=71.50mm)	BH-6107	
1	(L=1300mm) (L2=300mm) (A=71.50mm)	BH-6108	
1	(L=1400mm) (L2=300mm) (A=71.50mm)	BH-6109	
1	(L=1500mm) (L2=300mm) (A=71.50mm)	BH-6110	
1	(L=1600mm) (L2=300mm) (A=71.50mm)	BH-6111	
1	(L=1700mm) (L2=300mm) (A=71.50mm)	BH-6112	

BARRA K518 BLINDADA C/CAÑO REDONDO SEGURO A BOLITAS X 2 C/HORQ. FORJADA

FIG.	DESCRIPCIÓN	CÓDIGO	PRECIO
1	(L=500mm) (L2=300mm) (A=101.5mm)	BH-8100	
1	(L=600mm) (L2=300mm) (A=101.5mm)	BH-8101	
1	(L=700mm) (L2=300mm) (A=101.5mm)	BH-8102	
1	(L=800mm) (L2=300mm) (A=101.5mm)	BH-8103	
1	(L=900mm) (L2=300mm) (A=101.5mm)	BH-8104	
1	(L=1000mm) (L2=300mm) (A=101.5mm)	BH-8105	
1	(L=1100mm) (L2=300mm) (A=101.5mm)	BH-8106	
1	(L=1200mm) (L2=300mm) (A=101.5mm)	BH-8107	
1	(L=1300mm) (L2=300mm) (A=101.5mm)	BH-8108	
1	(L=1400mm) (L2=300mm) (A=101.5mm)	BH-8109	
1	(L=1500mm) (L2=300mm) (A=101.5mm)	BH-8110	
1	(L=1600mm) (L2=300mm) (A=101.5mm)	BH-8111	
1	(L=1700mm) (L2=300mm) (A=101.5mm)	BH-8112	

BARRA K521 BLINDADA C/CAÑO REDONDO SEGURO A BOLITAS X 2 C/HORQ. FORJADA

FIG.	DESCRIPCIÓN	CÓDIGO	PRECIO
1	(L=500mm) (L2=300mm) (A=96.6mm)	BH-2100	
1	(L=600mm) (L2=300mm) (A=96.6mm)	BH-2101	
1	(L=700mm) (L2=300mm) (A=96.6mm)	BH-2102	
1	(L=800mm) (L2=300mm) (A=96.6mm)	BH-2103	
1	(L=900mm) (L2=300mm) (A=96.6mm)	BH-2104	
1	(L=1000mm) (L2=300mm) (A=96.6mm)	BH-2105	
1	(L=1100mm) (L2=300mm) (A=96.6mm)	BH-2106	
1	(L=1200mm) (L2=300mm) (A=96.6mm)	BH-2107	
1	(L=1300mm) (L2=300mm) (A=96.6mm)	BH-2108	
1	(L=1400mm) (L2=300mm) (A=96.6mm)	BH-2109	
1	(L=1500mm) (L2=300mm) (A=96.6mm)	BH-2110	
1	(L=1600mm) (L2=300mm) (A=96.6mm)	BH-2111	
1	(L=1700mm) (L2=300mm) (A=96.6mm)	BH-2112	

BARRA K514 BLINDADA C/CAÑO REDONDO SEGURO A BOLITAS X 2 C/HORQ. FORJADA

FIG.	DESCRIPCIÓN	CÓDIGO	PRECIO
1	(L=500mm) (L2=300mm) (A=105.4mm)	BH-4100	
1	(L=600mm) (L2=300mm) (A=105.4mm)	BH-4101	
1	(L=700mm) (L2=300mm) (A=105.4mm)	BH-4102	
1	(L=800mm) (L2=300mm) (A=105.4mm)	BH-4103	
1	(L=900mm) (L2=300mm) (A=105.4mm)	BH-4104	
1	(L=1000mm) (L2=300mm) (A=105.4mm)	BH-4105	
1	(L=1100mm) (L2=300mm) (A=105.4mm)	BH-4106	
1	(L=1200mm) (L2=300mm) (A=105.4mm)	BH-4107	
1	(L=1300mm) (L2=300mm) (A=105.4mm)	BH-4108	
1	(L=1400mm) (L2=300mm) (A=105.4mm)	BH-4109	
1	(L=1500mm) (L2=300mm) (A=105.4mm)	BH-4110	
1	(L=1600mm) (L2=300mm) (A=105.4mm)	BH-4111	
1	(L=1700mm) (L2=300mm) (A=105.4mm)	BH-4112	

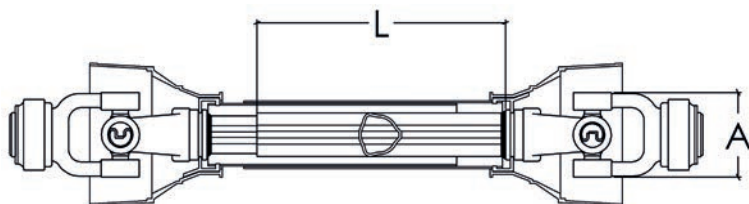

FIG. 1

BARRA K526 BLINDADA C/CAÑO TRILOBULAR SEGURO A BOLITAS X 2 C/HORQ. FORJADA

FIG.	DESCRIPCIÓN	CÓDIGO	PRECIO
1	(L=500mm) (A=71.50mm)	BTH-6100	
1	(L=600mm) (A=71.50mm)	BTH-6101	
1	(L=700mm) (A=71.50mm)	BTH-6102	
1	(L=800mm) (A=71.50mm)	BTH-6103	
1	(L=900mm) (A=71.50mm)	BTH-6104	
1	(L=1000mm) (A=71.50mm)	BTH-6105	
1	(L=1100mm) (A=71.50mm)	BTH-6106	
1	(L=1200mm) (A=71.50mm)	BTH-6107	
1	(L=1300mm) (A=71.50mm)	BTH-6108	
1	(L=1400mm) (A=71.50mm)	BTH-6109	
1	(L=1500mm) (A=71.50mm)	BTH-6110	
1	(L=1600mm) (A=71.50mm)	BTH-6111	
1	(L=1700mm) (A=71.50mm)	BTH-6112	

BARRA K518 BLINDADA C/CAÑO TRILOBULAR SEGURO A BOLITAS X 2 C/HORQ. FORJADA

FIG.	DESCRIPCIÓN	CÓDIGO	PRECIO
1	(L=500mm) (A=101.5mm)	BTH-8100	
1	(L=600mm) (A=101.5mm)	BTH-8101	
1	(L=700mm) (A=101.5mm)	BTH-8102	
1	(L=800mm) (A=101.5mm)	BTH-8103	
1	(L=900mm) (A=101.5mm)	BTH-8104	
1	(L=1000mm) (A=101.5mm)	BTH-8105	
1	(L=1100mm) (A=101.5mm)	BTH-8106	
1	(L=1200mm) (A=101.5mm)	BTH-8107	
1	(L=1300mm) (A=101.5mm)	BTH-8108	
1	(L=1400mm) (A=101.5mm)	BTH-8109	
1	(L=1500mm) (A=101.5mm)	BTH-8110	
1	(L=1600mm) (A=101.5mm)	BTH-8111	
1	(L=1700mm) (A=101.5mm)	BTH-8112	

BARRA K521 BLINDADA C/CAÑO TRILOBULAR SEGURO A BOLITAS X 2 C/HORQ. FORJADA

FIG.	DESCRIPCIÓN	CÓDIGO	PRECIO
1	(L=500mm) (A=96.6mm)	BTH-2100	
1	(L=600mm) (A=96.6mm)	BTH-2101	
1	(L=700mm) (A=96.6mm)	BTH-2102	
1	(L=800mm) (A=96.6mm)	BTH-2103	
1	(L=900mm) (A=96.6mm)	BTH-2104	
1	(L=1000mm) (A=96.6mm)	BTH-2105	
1	(L=1100mm) (A=96.6mm)	BTH-2106	
1	(L=1200mm) (A=96.6mm)	BTH-2107	
1	(L=1300mm) (A=96.6mm)	BTH-2108	
1	(L=1400mm) (A=96.6mm)	BTH-2109	
1	(L=1500mm) (A=96.6mm)	BTH-2110	
1	(L=1600mm) (A=96.6mm)	BTH-2111	
1	(L=1700mm) (A=96.6mm)	BTH-2112	

BARRA K514 BLINDADA C/CAÑO TRILOBULAR SEGURO A BOLITAS X 2 C/HORQ. FORJADA

FIG.	DESCRIPCIÓN	CÓDIGO	PRECIO
1	(L=500mm) (A=105.4mm)	BTH-4100	
1	(L=600mm) (A=105.4mm)	BTH-4101	
1	(L=700mm) (A=105.4mm)	BTH-4102	
1	(L=800mm) (A=105.4mm)	BTH-4103	
1	(L=900mm) (A=105.4mm)	BTH-4104	
1	(L=1000mm) (A=105.4mm)	BTH-4105	
1	(L=1100mm) (A=105.4mm)	BTH-4106	
1	(L=1200mm) (A=105.4mm)	BTH-4107	
1	(L=1300mm) (A=105.4mm)	BTH-4108	
1	(L=1400mm) (A=105.4mm)	BTH-4109	
1	(L=1500mm) (A=105.4mm)	BTH-4110	
1	(L=1600mm) (A=105.4mm)	BTH-4111	
1	(L=1700mm) (A=105.4mm)	BTH-4112	

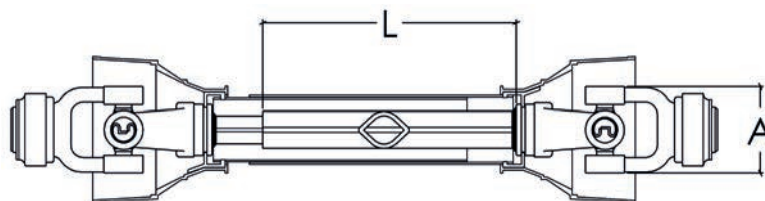

FIG. 1

**BARRA K526 BLINDADA C/CAÑO OVOIDAL
SEGURO A BOLITAS X 2 C/HORQ. FORJADA**

FIG.	DESCRIPCIÓN	CÓDIGO	PRECIO
1	(L=500mm) (A=71.50mm)	BOH-6100	
1	(L=600mm) (A=71.50mm)	BOH-6101	
1	(L=700mm) (A=71.50mm)	BOH-6102	
1	(L=800mm) (A=71.50mm)	BOH-6103	
1	(L=900mm) (A=71.50mm)	BOH-6104	
1	(L=1000mm) (A=71.50mm)	BOH-6105	
1	(L=1100mm) (A=71.50mm)	BOH-6106	
1	(L=1200mm) (A=71.50mm)	BOH-6107	
1	(L=1300mm) (A=71.50mm)	BOH-6108	
1	(L=1400mm) (A=71.50mm)	BOH-6109	
1	(L=1500mm) (A=71.50mm)	BOH-6110	
1	(L=1600mm) (A=71.50mm)	BOH-6111	
1	(L=1700mm) (A=71.50mm)	BOH-6112	

**BARRA K518 BLINDADA C/CAÑO OVOIDAL
SEGURO A BOLITAS X 2 C/HORQ. FORJADA**

FIG.	DESCRIPCIÓN	CÓDIGO	PRECIO
1	(L=500mm) (A=101.5mm)	BOH-8100	
1	(L=600mm) (A=101.5mm)	BOH-8101	
1	(L=700mm) (A=101.5mm)	BOH-8102	
1	(L=800mm) (A=101.5mm)	BOH-8103	
1	(L=900mm) (A=101.5mm)	BOH-8104	
1	(L=1000mm) (A=101.5mm)	BOH-8105	
1	(L=1100mm) (A=101.5mm)	BOH-8106	
1	(L=1200mm) (A=101.5mm)	BOH-8107	
1	(L=1300mm) (A=101.5mm)	BOH-8108	
1	(L=1400mm) (A=101.5mm)	BOH-8109	
1	(L=1500mm) (A=101.5mm)	BOH-8110	
1	(L=1600mm) (A=101.5mm)	BOH-8111	
1	(L=1700mm) (A=101.5mm)	BOH-8112	

**BARRA K521 BLINDADA C/CAÑO OVOIDAL
SEGURO A BOLITAS X 2 C/HORQ. FORJADA**

FIG.	DESCRIPCIÓN	CÓDIGO	PRECIO
1	(L=500mm) (A=96.6mm)	BOH-2100	
1	(L=600mm) (A=96.6mm)	BOH-2101	
1	(L=700mm) (A=96.6mm)	BOH-2102	
1	(L=800mm) (A=96.6mm)	BOH-2103	
1	(L=900mm) (A=96.6mm)	BOH-2104	
1	(L=1000mm) (A=96.6mm)	BOH-2105	
1	(L=1100mm) (A=96.6mm)	BOH-2106	
1	(L=1200mm) (A=96.6mm)	BOH-2107	
1	(L=1300mm) (A=96.6mm)	BOH-2108	
1	(L=1400mm) (A=96.6mm)	BOH-2109	
1	(L=1500mm) (A=96.6mm)	BOH-2110	
1	(L=1600mm) (A=96.6mm)	BOH-2111	
1	(L=1700mm) (A=96.6mm)	BOH-2112	

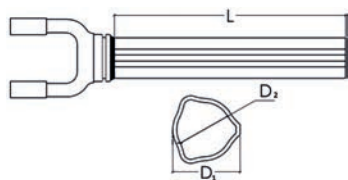

FIG. 1

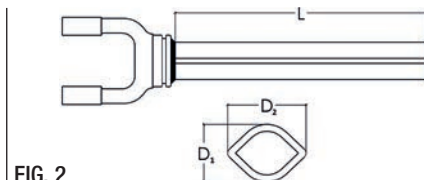

FIG. 2

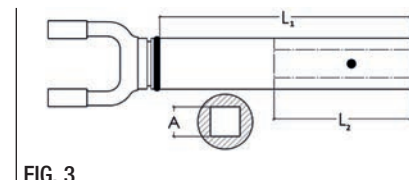

FIG. 3

FIG.	DESCRIPCIÓN	CÓDIGO	PRECIO
CAÑO TRILOBULAR C/HORQ. FORJADA			
1	CAÑO TRILOBULAR K514 MACHO (L=500mm) (D1=45mm) (D2=30.20mm) C/HORQ.FORJADA	CTH-41060	
	AGREGAR CADA 100mm	CTH-41060/1	
1	CAÑO TRILOBULAR K514 HEMBRA (L=500mm) (D1=53.6mm) (D2=41.70mm) C/HORQ. FORJADA	CTH-41190	
	AGREGAR CADA 100mm	CTH-41190/1	
1	CAÑO TRILOBULAR K518 MACHO (L=500mm) (D1=45mm) (D2=33.20mm) C/HORQ. FORJADA	CTH-81060	
	AGREGAR CADA 100mm	CTH-81060/1	
1	CAÑO TRILOBULAR K518 HEMBRA (L=500mm) (D1=52mm) (D2=41.70mm) C/HORQ. FORJADA	CTH-81190	
	AGREGAR CADA 100mm	CTH-81190/1	
1	CAÑO TRILOBULAR K521 MACHO (L=500mm) (D1=36mm) (D2=27.60mm) C/HORQ. FORJADA	CTH-11060	
	AGREGAR CADA 100mm	CTH-11060/1	
1	CAÑO TRILOBULAR K521 HEMBRA (L=500mm) (D1=44mm) (D2=34.00mm) C/HORQ. FORJADA	CTH-11190	
	AGREGAR CADA 100mm	CTH-11190/1	
1	CAÑO TRILOBULAR K526 MACHO (L=500mm) (D1=29mm) (D2=20.30mm) C/HORQ. FORJADA	CTH-61060	
	AGREGAR CADA 100mm	CTH-61060/1	
1	CAÑO TRILOBULAR K526 HEMBRA (L=500mm) (D1=37mm) (D2=27.60mm) C/HORQ. FORJADA	CTH-61190	
	AGREGAR CADA 100mm	CTH-61190/1	
CAÑO OVOIDAL C/HORQ. FORJADA			
2	CAÑO OVOIDAL K518 MACHO (L=500mm) (D1=43.5mm) (D2=51.9mm) C/HORQ. FORJADA	COH-81060	
	AGREGAR CADA 100mm	COH-81060/1	
2	CAÑO OVOIDAL K518 HEMBRA (L=500mm) (D1=52mm) (D2=67mm) C/HORQ. FORJADA	COH-81190	
	AGREGAR CADA 100mm	COH-81190/1	
2	CAÑO OVOIDAL K521 MACHO (L=500mm) (D1=36.5mm) (D2=46.7mm) C/HORQ. FORJADA	COH-11060	
	AGREGAR CADA 100mm	COH-11060/1	
2	CAÑO OVOIDAL K521 HEMBRA (L=500mm) (D1=43mm) (D2=54.4mm) C/HORQ. FORJADA	COH-11190	
	AGREGAR CADA 100mm	COH-11190/1	
2	CAÑO OVOIDAL K526 MACHO (L=500mm) (D1=30.5mm) (D2=36.8mm) C/HORQ. FORJADA	COH-61060	
	AGREGAR CADA 100mm	COH-61060/1	
2	CAÑO OVOIDAL K526 HEMBRA (L=500mm) (D1=37mm) (D2=54.4mm) C/HORQ. FORJADA	COH-61190	
	AGREGAR CADA 100mm	COH-61190/1	
CAÑO CON BUJE CUADRADO C/HORQ. FORJADA			
3	CAÑO C/BUJE CUADRADO (L1=500mm) (L2=110mm) (A=1 1/4") C/HORQ. FORJADA K514	CH-3128	
	AGREGAR CADA 100mm	CH-3128/1	
3	CAÑO C/BUJE CUADRADO (L1=500mm) (L2=110mm) (A=1 1/4") C/HORQ. FORJADA K518	CH-3128	
	AGREGAR CADA 100mm	CH-3128/1	
3	CAÑO C/BUJE CUADRADO (L1=500mm) (L2=110mm) (A=1") C/HORQ. FORJADA K521	CH-3116	
	AGREGAR CADA 100mm	CH-3116/1	
3	CAÑO C/BUJE CUADRADO (L1=500mm) (L2=110mm) (A=7/8") C/HORQ. FORJADA K526	CH-3104	
	AGREGAR CADA 100mm	CH-3104/1	

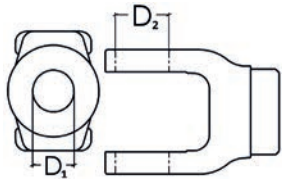

FIG. 1

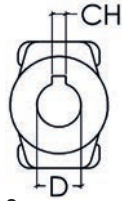

FIG. 2

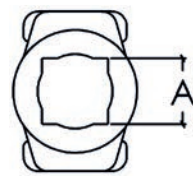

FIG. 3

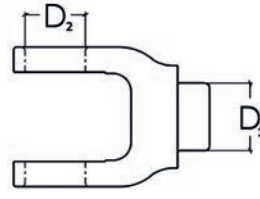
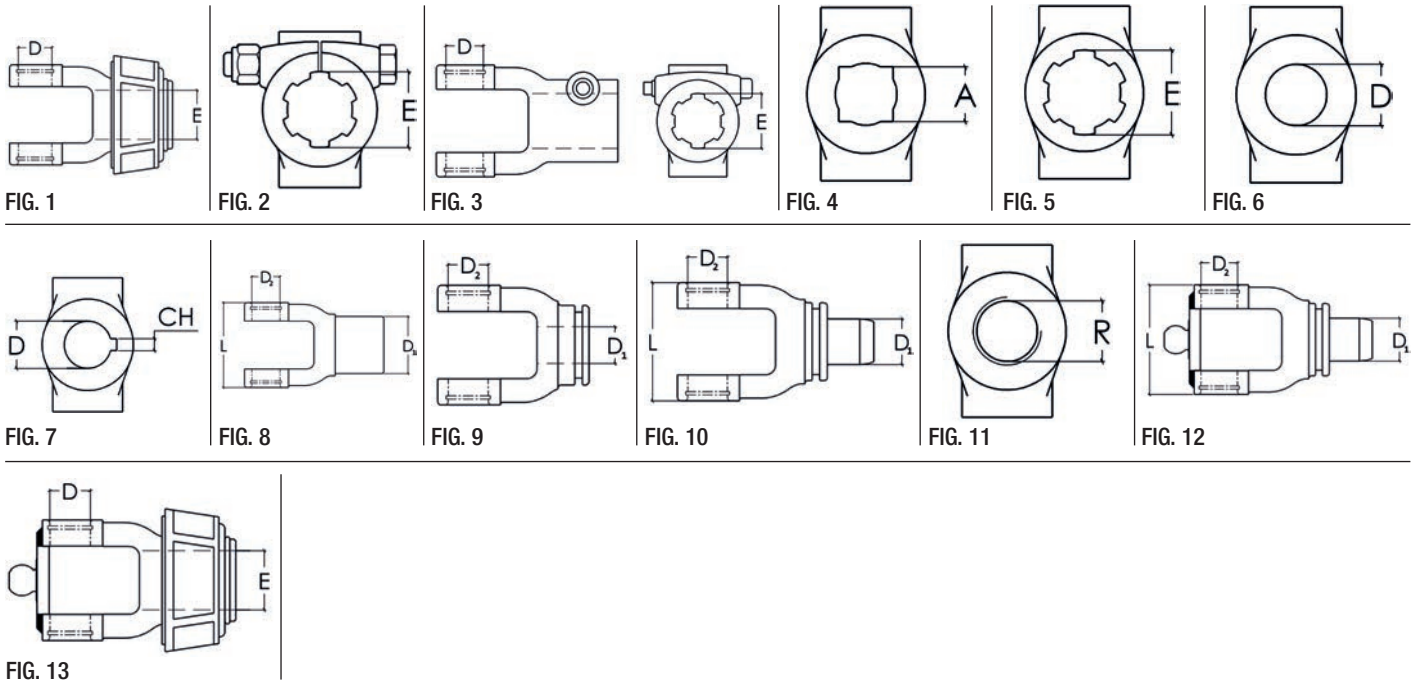

FIG. 4

HORQUILLAS FORJADAS K530

FIG.	DESCRIPCIÓN	CÓDIGO	PRECIO
1	HORQUILLA K530 LISA (D=19mm) (D2=24.6mm)	H-3000	
1	HORQUILLA K530 LISA (D=20mm) (D2=26.6mm)	H-3010	
1	HORQUILLA K530 LISA (D=22mm) (D2=26.6mm)	H-3020	
1	HORQUILLA K530 LISA (D=25mm) (D2=26.6mm)	H-3030	
2	HORQUILLA K530 (D=19mm) (CH=6X3mm)	H-3001	
2	HORQUILLA K530 (D=20mm) (CH=6X3mm)	H-3011	
2	HORQUILLA K530 (D=22mm) (CH=6X3mm)	H-3021	
2	HORQUILLA K530 (D=25mm) (CH=6X3mm)	H-3031	
3	HORQUILLA K530 INTERIOR CUADRADO (A=7/8")	H-3050	
4	HORQUILLA K530 CIEGA P/CAÑO REDONDO (D1=36.1mm) (D2=24.6mm)	H-3040	
4	HORQUILLA K530 P/CAÑO TRILOBULAR MACHO (D1=20.4mm) (D2=24.6mm)	H-3070	
4	HORQUILLA K530 P/CAÑO TRILOBULAR HEMBRA (D1=27.65mm) (D2=24.6mm)	H-3080	



HORQUILLAS FORJADAS K526

FIG.	DESCRIPCIÓN	CÓDIGO	PRECIO
1	HORQUILLA K526 SEGURO A BOLITAS (E=6 1 3/8") (D=23.84mm)	H-6000	
1	HORQUILLA K526 SEGURO A BOLITAS HEXAGONAL 1 1/8" (D=23.84mm)	H-6000/1	
1	HORQUILLA K526 SEGURO A BOLITAS (E=21 1 3/8") (D=23.84mm)	H-6000/2	
2	HORQUILLA K526 SEGURO A BULÓN CORT. (E=6 1 3/8")	H-6001/1	
3	HORQUILLA K526 SEGURO A BOTÓN (E=6 1 3/8") (D=23.84mm)	H-6001	
4	HORQUILLA K526 INT. CUADRADO (A=7/8")	H-6008	
5	HORQUILLA K526 INTERIOR (E=6 1 3/8")	H-6009	
6	HORQUILLA K526 (D=22mm) LISA	H-6002	
6	HORQUILLA K526 (D=25mm) LISA	H-6003	
6	HORQUILLA K526 (D=30mm) LISA	H-6004	
7	HORQUILLA K526 (D=22mm) (CH=6X3mm)	H-6019	
7	HORQUILLA K526 (D=25mm) (CH=6X3mm)	H-6005	
7	HORQUILLA K526 (D=30mm) (CH=8X4mm)	H-6006	
7	HORQUILLA K526 (D=35mm) (CH=8X4mm)	H-6007	
8	HORQUILLA K526 CIEGA (D1=48mm) (D2=23.84mm)	H-6013	
9	HORQUILLA K526 PARA EJE CUADRADO C/PROT. (D1=22mm) (D2=23.84mm)	H-6012	
10	HORQUILLA K526 PARA CAÑO C/PROT. (D1=36.60mm) (D2=23.84mm)	H-6011	
10	HORQUILLA K526 PARA CAÑO TRI. MACHO C/PROT. (D1=20.30mm) (D2=23.84mm)	H-6015	
10	HORQUILLA K526 PARA CAÑO TRI. HEMBRA C/PROT. (D1=27.70mm) (D2=23.84mm)	H-6016	
10	HORQUILLA K526 PARA CAÑO OVOIDAL MACHO C/PROT. (D1=24.65mm) (D2=23.84mm)	H-6017	
10	HORQUILLA K526 PARA CAÑO OVOIDAL HEMBRA C/PROT. (D1=31.40mm) (D2=23.84mm)	H-6018	
11	HORQUILLA K526 (R=ROSCA IZQ. 1" NF)	H-6010	
12	HORQUILLA K526 PARA CAÑO TRI. HEMBRA P/JUNTA HOMOCINÉTICA (D1=27.70mm) (D2=23.84mm)	H-6020	
13	HORQUILLA K526 S/BOL. PARA JUNTA HOMOCINÉTICA (E=6 1 3/8") (D=23.84mm)	H-6014	

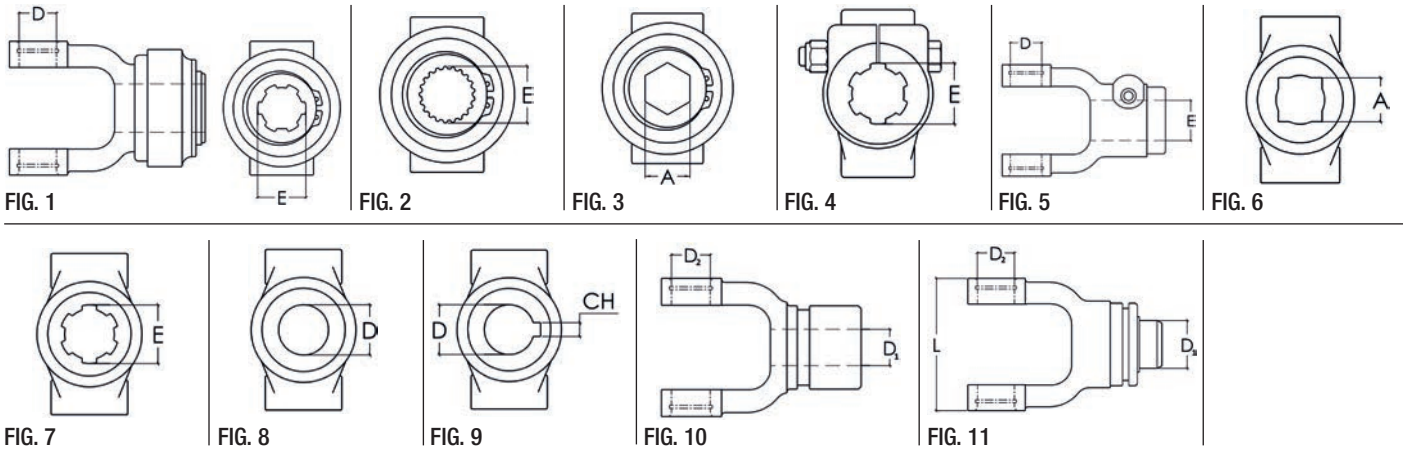

HORQUILLAS FORJADAS K521

FIG.	DESCRIPCIÓN	CÓDIGO	PRECIO
1	HORQUILLA K521 SEGURO A BOLITAS (E=6 1 3/8") (D=27.00)	H-1000	
2	HORQUILLA K521 SEGURO A BOLITAS (E=21 1 3/8")	H-1014	
3	HORQUILLA K521 SEGURO A BOLITAS HEXAGONAL (A=1 1/8")	H-1013	
4	HORQUILLA K521 SEGURO A BULÓN (E=6 1 3/8")	H-1020/1	
5	HORQUILLA K521 SEGURO A BOTÓN (E=6 1 3/8") (D=27mm)	H-1020	
5	HORQUILLA K521 SEGURO A BOTÓN HEXAGONAL 1 1/8" (D=27mm)	H-1020/2	
6	HORQUILLA K521 INT. CUADRADO (A=1")	H-1007	
7	HORQUILLA K521 (E=6 1 3/8")	H-1008	
8	HORQUILLA K521 (D=25mm) LISA	H-1001	
8	HORQUILLA K521 (D=30mm) LISA	H-1002	
8	HORQUILLA K521 (D=35mm) LISA	H-1003	
9	HORQUILLA K521 (D=25mm) (CH=6X3mm)	H-1004	
9	HORQUILLA K521 (D=30mm) (CH=8X4mm)	H-1005	
9	HORQUILLA K521 (D=35mm) (CH=8X4mm)	H-1006	
10	HORQUILLA K521 PARA EJE CUADRADO 1" C/PROT. (D1=25mm) (D2=27mm)	H-1010	
11	HORQUILLA K521 CIEGA PARA CAÑO C/PROT. (D1=42.50mm) (D2=27mm)	H-1009	
11	HORQUILLA K521 PARA CAÑO TRILOBULAR MACHO C/PROT. (D1=27.50mm) (D2=27mm)	H-1011	
11	HORQUILLA K521 PARA CAÑO TRILOB. HEMBRA C/PROT. (D1=34.60mm) (D2=27mm)	H-1012	
11	HORQUILLA K521 PARA CAÑO OVOIDAL HEMBRA C/PROT (D1=37.40mm) (D2=27mm)	H-1015	
11	HORQUILLA K521 PARA CAÑO OVOIDAL MACHO C/PROT. ((D1=27.50mm) (D2=27mm)	H-1016	

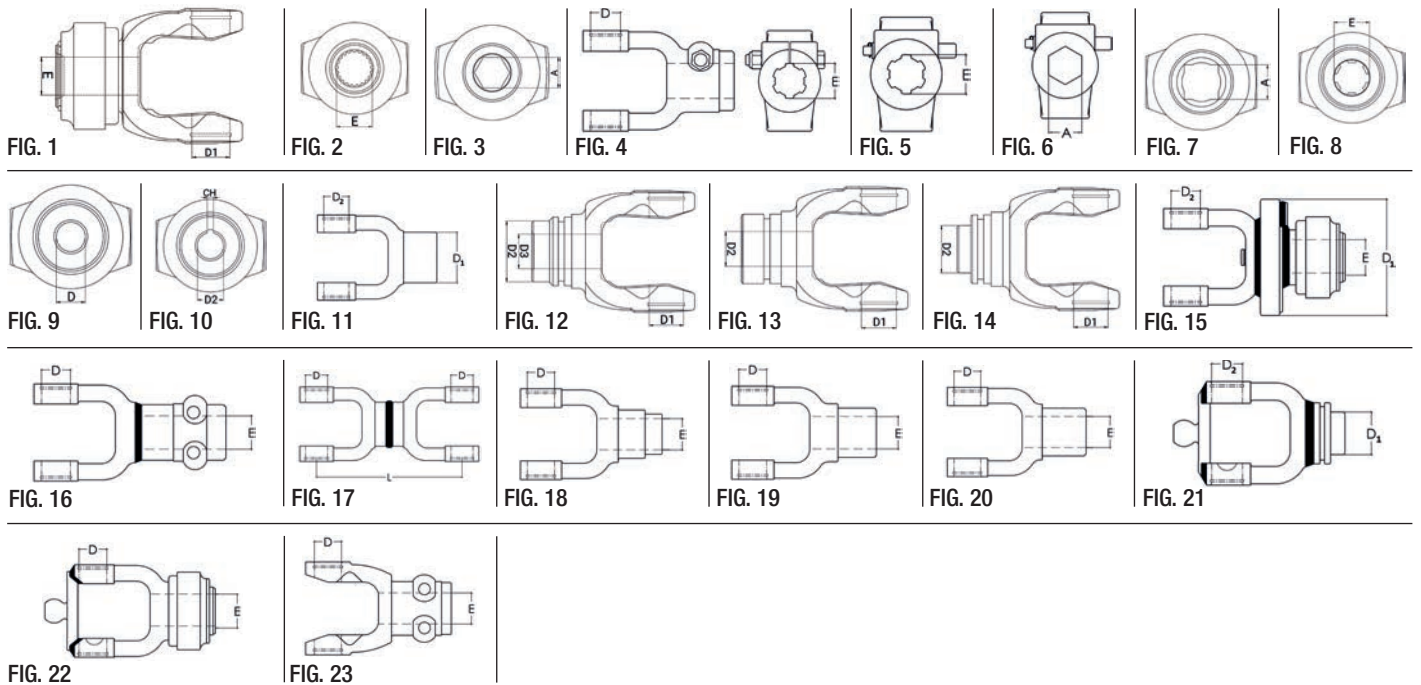

HORQUILLAS FORJADAS K518

FIG.	DESCRIPCIÓN	CÓDIGO	PRECIO
1	HORQUILLA K518 S/BOL. (E=6 1 3/8") (D=30.18mm)	H-8000	
2	HORQUILLA K518 S/BOL. (E=21 1 3/8")	H-8000/1	
3	HORQUILLA K518 S/BOL. HEXAGONAL (A=1 1/8")	H-8000/2	
4	HORQUILLA K518 SEGURO A BULON (E=6 1 3/8") (D=30.18mm)	H-8017	
5	HORQUILLA K518 SEGURO A BOTON (E=6 1 3/8")	H-8001	
6	HOQUILLA K518 SEGURO A BOTON HEXAGONAL (A=1 1/8")	H-8014	
7	HORQUILLA K518 INTERIOR CUADRADO (A=1 1/4")	H-8008	
8	HORQUILLA K518 INTERIOR (E=6 1 3/8")	H-8009	
9	HORQUILLA K518 (D=25mm) LISA	H-8013	
9	HORQUILLA K518 (D=30mm) LISA	H-8002	
9	HORQUILLA K518 (D=35mm) LISA	H-8003	
9	HORQUILLA K518 (D=40mm) LISA	H-8004	
10	HORQUILLA K518 (D=25mm) (CH=8X4mm)	H-8033	
10	HORQUILLA K518 (D=30mm) (CH=8X4mm)	H-8005	
10	HORQUILLA K518 (D=35mm) (CH=8X4mm)	H-8006	
10	HORQUILLA K518 (D=40mm) (CH=10X5mm)	H-8007	
11	HORQUILLA K518 CIEGA (D1=60mm) (D2=30.18mm)	H-8012	
12	HORQUILLA K518 P/CAÑO Y EJE CUADRADO C/PROT. (D1=53.5mm) (D2=30.18mm)	H-8031	
13	HORQUILLA K518 PARA EJE CUADRADO 1 1/4" C/PROT (D1=30mm) (D2=30.18mm)	H-8011	
14	HORQUILLA K518 PARA CAÑO C/PROT (D1=53.4mm) (D2=30.18mm)	H-8010	
14	HORQUILLA K518 P/CAÑO TRI. MACHO C/PROT (D1=40mm) (D2=30.18mm)	H-8015	
14	HORQUILLA K518 P/CAÑO TRI. HEMBRA C/PROT (D1=41.5mm) (D2=30.18mm)	H-8016	
14	HORQUILLA K518 P/CAÑO OVOIDAL MACHO C/PROT (D1=32.2mm) (D2=30.18mm)	H-8021	
14	HORQUILLA K518 P/CAÑO OVOIDAL HEMBRA C/PROT (D1=44.65mm) (D2=30.18mm)	H-8022	
15	HORQUILLA K518 S/BOL C/GIRO 40° (E=6 1 3/8") (D1=121mm) (D2=30.18mm)	H-8023	
16	HORQUILLA K518 CON BUJE ESTRIADO PARTIDO SOLDADO (E=6 1 3/4") (D=30.18mm)	H-8026	
17	HORQUILLA K518 HORQ DOBLE YOMEL (L=199.38mm) (D=30.18mm)	H-8028	
18	HORQUILLA K518 YOMEL "A" (E=6 1 3/8") (D=30.18mm)	H-8018	
19	HORQUILLA K518 YOMEL "B" (E=6 1 3/8") (D=30.18mm)	H-8019	
20	HORQUILLA K518 HILCOR (E=6 1 3/8") (D=30.18mm)	H-8024	
21	HORQUILLA K518 P/CAÑO TRI. HEMBRA P/JUNTA HOMOCINÉTICA (D1=41.5mm) (D2=30.18mm)	H-8030	
22	HORQUILLA K518 S/BOL. P/JUNTA HOMOCINÉTICA (E=6 1 3/8") (D=30.18mm)	H-8029	
23	HORQUILLA K518 DOBLE BULÓN (E=6 1 3/8") (D=30.18mm)	H-8025	
23	HORQUILLA K518 DOBLE BULÓN (E=21 1 3/8") (D=30.18mm)	H-8025/1	

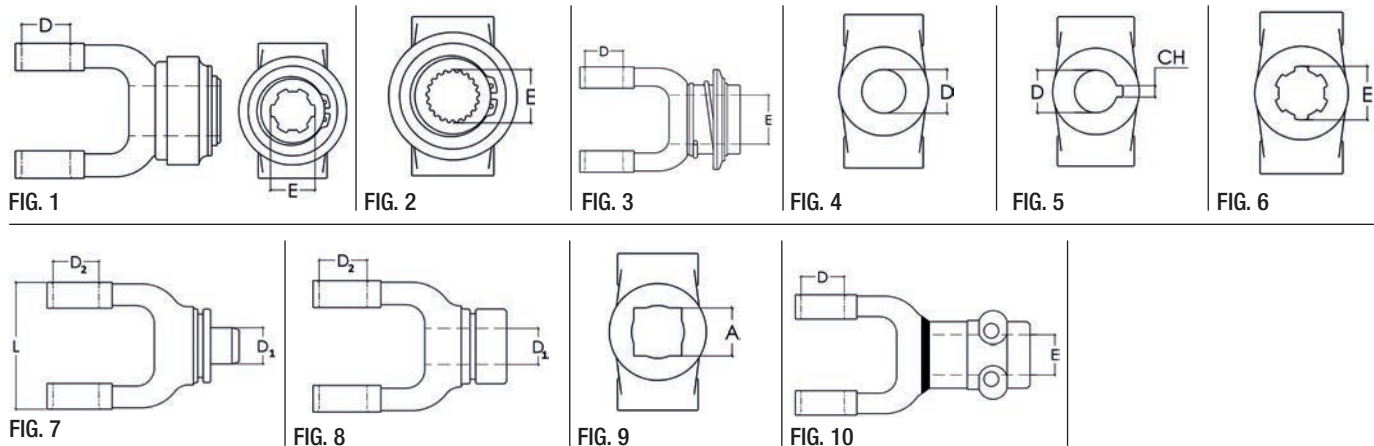

HORQUILLAS FORJADAS K514

FIG.	DESCRIPCIÓN	CÓDIGO	PRECIO
1	HORQUILLA K514 SEGURO A BOLITAS (E=6 1 3/8") (D=38.06mm)	H-4000	
2	HORQUILLA K514 SEGURO A BOLITAS (E=21 1 3/8")	H-4000/1	
3	HORQUILLA K514 SEGURO A BOLITAS (E=6 1 3/4") (D=38.06mm)	H-4000/2	
3	HORQUILLA K514 SEGURO A BOLITAS (E=20 1 3/4") (D=38.06mm)	H-4000/3	
4	HORQUILLA K514 (D=30mm) LISA	H-4001	
4	HORQUILLA K514 (D=35mm) LISA	H-4002	
4	HORQUILLA K514 (D=40mm) LISA	H-4003	
5	HORQUILLA K514 (D=30mm) (CH=8X4mm)	H-4004	
5	HORQUILLA K514 (D=35mm) (CH=8X4mm) (CH=10X5mm)	H-4005	
5	HORQUILLA K514 (D=40mm) (CH=10X5mm)	H-4006	
6	HORQUILLA K514 INTERIOR (E=6 1 3/8")	H-4007	
7	HORQUILLA K514 PARA CAÑO REDONDO C/PROT. (D1=53.9mm) (D2=38.06mm)	H-4008	
7	HORQUILLA K514 PARA CAÑO TRILOBULAR MACHO C/PROT. (D1=30.05mm) (D2=38.06mm)	H-4011	
7	HORQUILLA K514 PARA CAÑO TRILOBULAR HEMBRA C/PROT. (D1=41.7mm) (D2=38.06mm)	H-4012	
8	HORQUILLA K514 PARA EJE CUADRADO 1 1/4" C/PROT. (D1=30mm) (D2=38.06mm)	H-4009	
9	HORQUILLA K514 INTERIOR CUADRADO C/PROT. (A=1 1/4")	H-4010	
10	HORQUILLA K514 CON BUJE ESTRIADO PARTIDO SOLDADO (E=6 1 3/4") (D=38.06mm)	H-4013	
10	HORQUILLA K514 CON BUJE ESTRIADO PARTIDO SOLDADO (E=6 1 3/8") (D=38.06mm)	H-4014	

LÍNEA HORQUILLAS FUNDICIÓN NODULAR

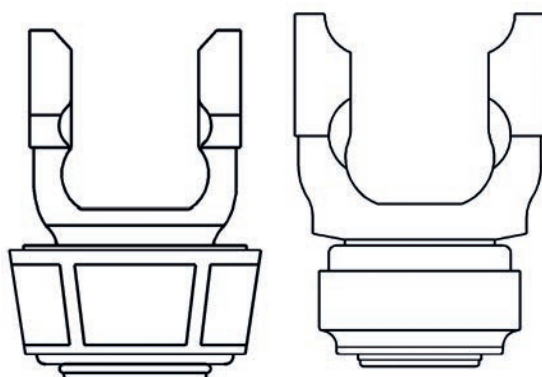

- MEDIAS BARRAS
- TRANSMISIONES CARDÁNICAS CON CAÑO TRILOBULAR (K518 - K526)
- TRANSMISIONES CARDÁNICAS CON CAÑO CUADROLOBULAR (Nº8)
- CAÑOS CON HORQUILLAS ESPINADAS (K518 - K526)
- HORQUILLAS K526
- HORQUILLAS K518
- HORQUILLAS Nº8



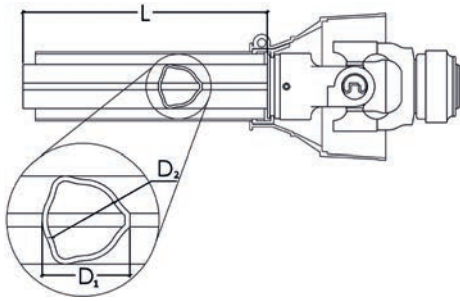

FIG. 1

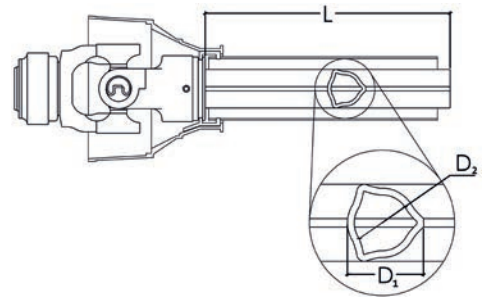

FIG. 2

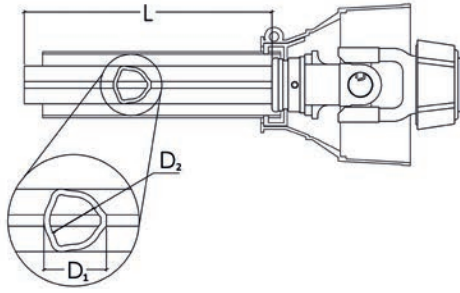

FIG. 3

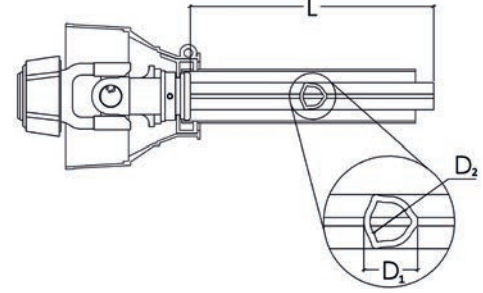

FIG. 4

MEDIAS BARRAS TRILOBULAR C/HORQ. NODULAR

FIG.	DESCRIPCIÓN	CÓDIGO	PRECIO
1	1/2 BARRA K526 TRI. MACHO S/BOL. (L=900mm) (D1=29mm) (D2=20.3mm) BLIND.	MBMTHN-0500	
2	1/2 BARRA K518 TRI. MACHO S/BOL. (L=900mm) (D1=45mm) (D2=33.2mm) BLIND.	MBMTHN-0700	
3	1/2 BARRA K526 TRI. HEMBRA S/BOL. (L=500mm) (D1=37mm) (D2=27.6mm) BLIND.	MBHTHN-0500	
	AGREGAR CADA 100mm	MBHTHN-0600/1	
4	1/2 BARRA K518 TRI. HEMBRA S/BOL. (L=500mm) (D1=52mm) (D2=41.7mm) BLIND.	MBHTHN-0700	
	AGREGAR CADA 100mm	MBHTHN-0700/1	

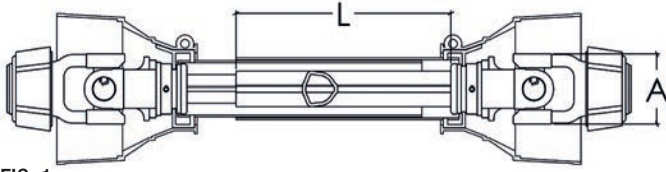

FIG. 1

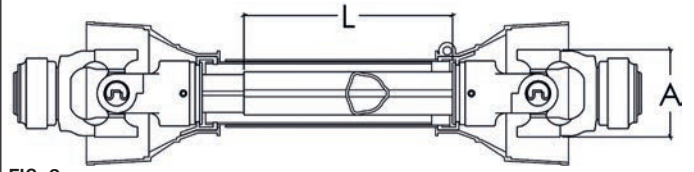

FIG. 2

**BARRA K526 BLINDADA C/CAÑO TRILOBULAR
SEGURO A BOLITAS X 2 C/HORQ. NODULAR**

FIG.	DESCRIPCIÓN	CÓDIGO	PRECIO
1	(L=500mm) (A=72mm)	BTHN-6100	
1	(L=600mm) (A=72mm)	BTHN-6101	
1	(L=700mm) (A=72mm)	BTHN-6102	
1	(L=800mm) (A=72mm)	BTHN-6103	
1	(L=900mm) (A=72mm)	BTHN-6104	
1	(L=1000mm) (A=72mm)	BTHN-6105	
1	(L=1100mm) (A=72mm)	BTHN-6106	
1	(L=1200mm) (A=72mm)	BTHN-6107	
1	(L=1300mm) (A=72mm)	BTHN-6108	
1	(L=1400mm) (A=72mm)	BTHN-6109	
1	(L=1500mm) (A=72mm)	BTHN-6110	
1	(L=1600mm) (A=72mm)	BTHN-6111	
1	(L=1700mm) (A=72mm)	BTHN-6112	

**BARRA K518 BLINDADA C/CAÑO TRILOBULAR
SEGURO A BOLITAS X 2 C/HORQ. NODULAR**

FIG.	DESCRIPCIÓN	CÓDIGO	PRECIO
2	(L=500mm) (A=105.1mm)	BTHN-8100	
2	(L=600mm) (A=105.1mm)	BTHN-8101	
2	(L=700mm) (A=105.1mm)	BTHN-8102	
2	(L=800mm) (A=105.1mm)	BTHN-8103	
2	(L=900mm) (A=105.1mm)	BTHN-8104	
2	(L=1000mm) (A=105.1mm)	BTHN-8105	
2	(L=1100mm) (A=105.1mm)	BTHN-8106	
2	(L=1200mm) (A=105.1mm)	BTHN-8107	
2	(L=1300mm) (A=105.1mm)	BTHN-8108	
2	(L=1400mm) (A=105.1mm)	BTHN-8109	
2	(L=1500mm) (A=105.1mm)	BTHN-8110	
2	(L=1600mm) (A=105.1mm)	BTHN-8111	
2	(L=1700mm) (A=105.1mm)	BTHN-8112	

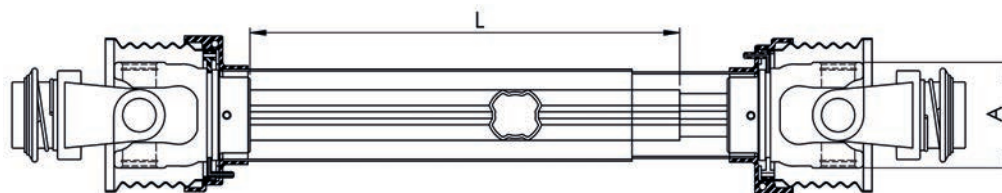

FIG. 1

**BARRA N°8 BLINDADA C/CAÑO CUADROLOBULAR
SEGURO A BOLITAS X 2 C/HORQ. NODULAR**

FIG.	DESCRIPCIÓN	CÓDIGO	PRECIO
1	(L=500mm) (A=108mm)	BCHN-N8100	
1	(L=600mm) (A=108mm)	BCHN-N8101	
1	(L=700mm) (A=108mm)	BCHN-N8102	
1	(L=800mm) (A=108mm)	BCHN-N8103	
1	(L=900mm) (A=108mm)	BCHN-N8104	
1	(L=1000mm) (A=108mm)	BCHN-N8105	
1	(L=1100mm) (A=108mm)	BCHN-N8106	
1	(L=1200mm) (A=108mm)	BCHN-N8107	
1	(L=1300mm) (A=108mm)	BCHN-N8108	
1	(L=1400mm) (A=108mm)	BCHN-N8109	
1	(L=1500mm) (A=108mm)	BCHN-N8110	
1	(L=1600mm) (A=108mm)	BCHN-N8111	
1	(L=1700mm) (A=108mm)	BCHN-N8112	

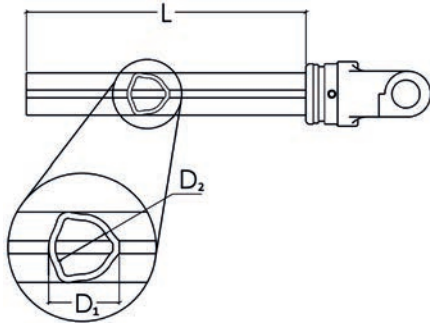

FIG. 1

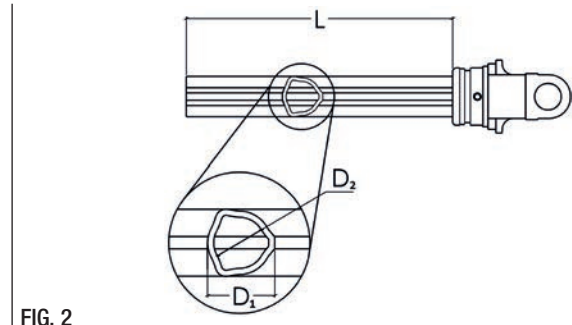

FIG. 2

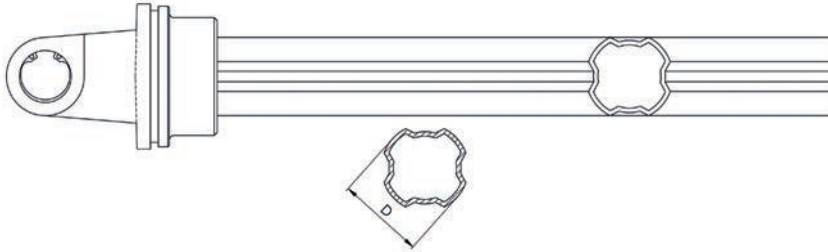

FIG. 3

FIG.	DESCRIPCIÓN	CÓDIGO	PRECIO
CAÑO TRILOBULAR C/HORQ. NODULAR			
1	CAÑO TRI. K518 MACHO (L=500mm) (D1=45mm) (D2=33.2mm) C/HORQ. NODULAR	CTHN-81060	
	AGREGAR CADA 100mm	CTHN-81060/1	
1	CAÑO TRI. K518 HEMBRA (L=500mm) (D1=52mm) (D2=41.7mm) C/HORQ. NODULAR	CTHN-81190	
	AGREGAR CADA 100mm	CTHN-81190/1	
2	CAÑO TRI. K526 MACHO (L=500mm) (D1=29mm) (D2=20.3mm) C/HORQ. NODULAR	CTHN-11060	
	AGREGAR CADA 100mm	CTHN-11060/1	
2	CAÑO TRI. K526 HEMBRA (L=500mm) (D1=37mm) (D2=27.6mm) C/HORQ. NODULAR	CTHN-11190	
	AGREGAR CADA 100mm	CTHN-11190/1	
CAÑO CUADROLOBULAR C/HORQ. NODULAR			
3	CAÑO CUADROLOBULAR N°8 MACHO (L=500mm) (D=51.5mm) C/HORQ. NODULAR	CCHN-N81060	
	AGREGAR CADA 100mm	CCHN-N81060/1	
3	CAÑO CUADROLOBULAR N°8 HEMBRA (L=500mm) (D=58.3mm) C/HORQ. NODULAR	CCHN-N81190	
	AGREGAR CADA 100mm	CCHN-N81190/1	

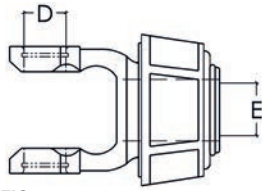

FIG. 1

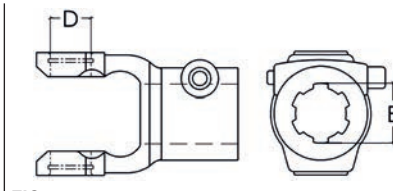

FIG. 2

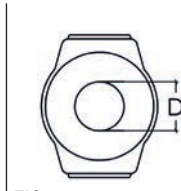

FIG. 3

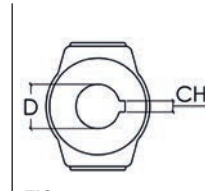

FIG. 4

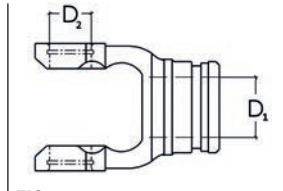

FIG. 5

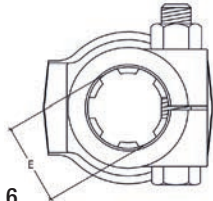

FIG. 6

HORQUILLAS NODULARES K526

FIG.	DESCRIPCIÓN	CÓDIGO	PRECIO
1	HORQUILLA K526 SEGURO A BOLITAS (E=6 1 3/8") (D=23.84mm)	HN-6000	
1	HORQUILLA K526 SEGURO A BOLITAS HEXAGONAL 1 1/8" (D=23.84mm)	H-6000/1	
1	HORQUILLA K526 SEGURO A BOLITAS (E=21 1 3/8") (D=23.84mm)	H-6000/2	
2	HORQUILLA K526 SEGURO A BOTÓN (E=6 1 3/8") (D=23.84mm)	HN-6001	
3	HORQUILLA K526 (D=22mm)	HN-6002	
3	HORQUILLA K526 (D=25mm)	HN-6003	
3	HORQUILLA K526 (D=30mm)	HN-6004	
4	HORQUILLA K526 (D=22mm) (CH=6X3mm)	HN-6019	
4	HORQUILLA K526 (D=25mm) (CH=6X3mm)	HN-6005	
4	HORQUILLA K526 (D=30mm) (CH=8X4mm)	HN-6006	
4	HORQUILLA K526 (D=50mm) (CH=8X4mm)	HN-6007	
5	HORQUILLA K526 PARA CAÑO TRI. MACHO C/PROT. (D1=27.1mm) (D2=23.84mm)	HN-6015	
5	HORQUILLA K526 PARA CAÑO TRI. HEMBRA C/PROT. (D1=33.75mm) (D2=23.84mm)	HN-6016	
6	HORQUILLA K526 SEGURO A BULÓN CORT. (E=6 1 3/8")	HN-6001/1	

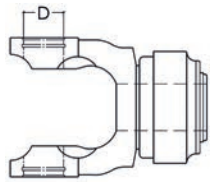

FIG. 1

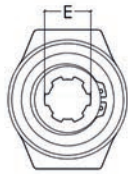

FIG. 2

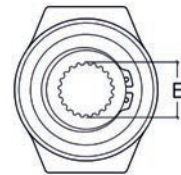

FIG. 3

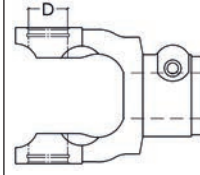

FIG. 4

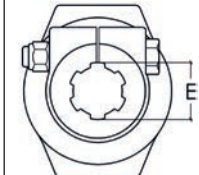

FIG. 5

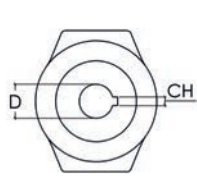

FIG. 6

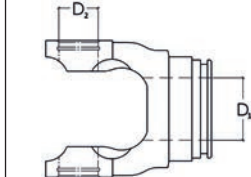

FIG. 7

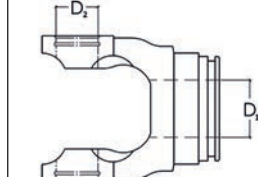

FIG. 8

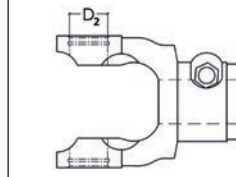

FIG. 9

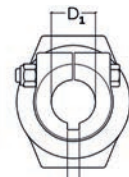

FIG. 10

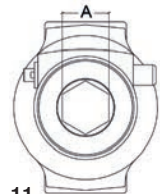

FIG. 11

HORQUILLAS NODULARES K518

FIG.	DESCRIPCIÓN	CÓDIGO	PRECIO
1	HORQUILLA K518 SEGURO A BOLITAS (E=6 1 3/8") (D=30.18mm)	HN-8000	
2	HORQUILLA K518 SEGURO A BOLITAS (E=21 1 3/8")	HN-8000/1	
3	HORQUILLA K518 SEGURO A BULÓN (E=6 1 3/8") (D=30.18mm)	HN-8017	
4	HORQUILLA K518 SEGURO A BOTÓN (E=6 1 3/8")	HN-8001	
5	HORQUILLA K518 (D=25mm) LISA	HN-8013	
5	HORQUILLA K518 (D=30mm) LISA	HN-8002	
5	HORQUILLA K518 (D=35mm) LISA	HN-8003	
5	HORQUILLA K518 (D=40mm) LISA	HN-8004	
6	HORQUILLA K518 (D=25mm) (CH=8X4mm)	HN-8033	
6	HORQUILLA K518 (D=30mm) (CH=8X4mm)	HN-8005	
6	HORQUILLA K518 (D=35mm) (CH=8X4mm)	HN-8006	
6	HORQUILLA K518 (D=40mm) (CH=10X5mm)	HN-8007	
7	HORQUILLA K518 P/CAÑO TRI. MACHO C/PROT. (D1=41mm) (D2=30.18mm)	HN-8015	
8	HORQUILLA K518 P/CAÑO TRI. HEMBRA C/PROT. (D1=47.85mm) (D2=30.18mm)	HN-8016	
9	HORQUILLA K518 JACTO (D1=35mm) (D2=30.18mm) (CH=3/8")	HN-8027	
10	HORQUILLA K518 S/BOL. HEXAGONAL (A=1 1/8")	HN-8000/2	
11	HOQUILLA K518 SEGURO A BOTON HEXAGONAL (A=1 1/8")	HN-8014	

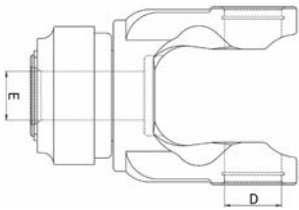

FIG. 1

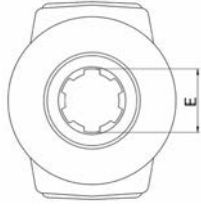

FIG. 2

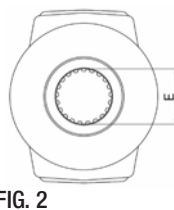

FIG. 3

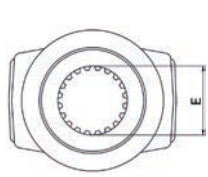
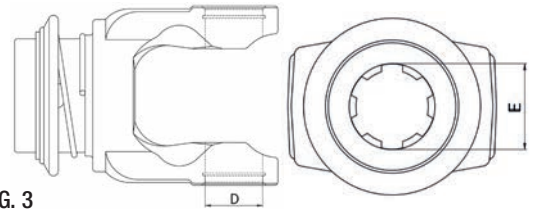

FIG. 4

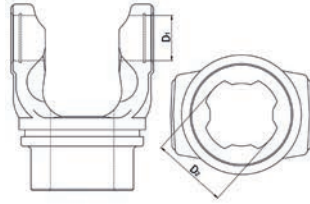
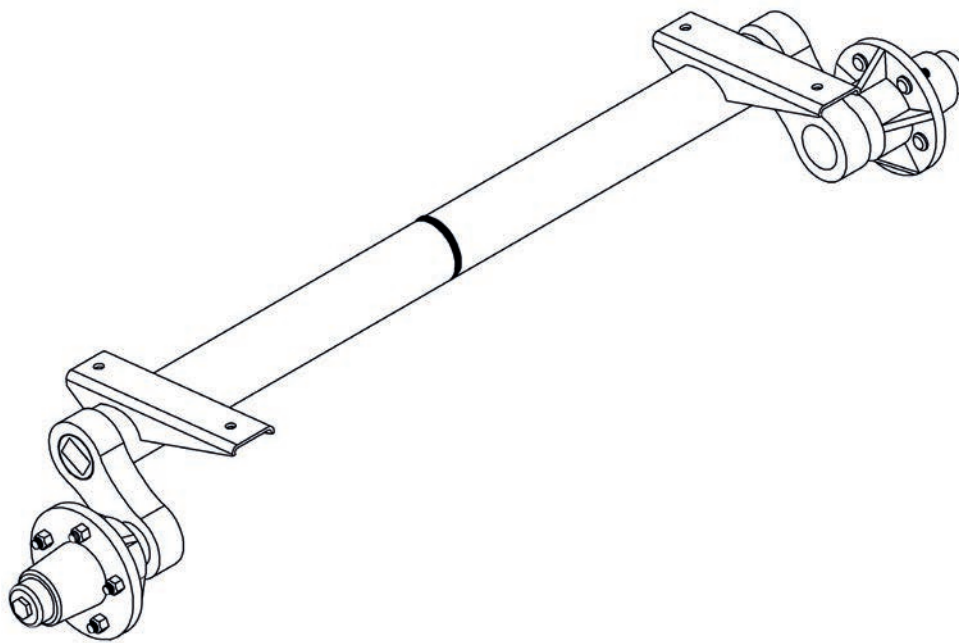

FIG. 5

HORQUILLAS NODULARES Nº8

FIG.	DESCRIPCIÓN	CÓDIGO	PRECIO
1	HORQUILLA Nº8 SEGURO A BOLITAS (E=6 1 3/8") (D=34.98mm)	HN-N8000	
2	HORQUILLA Nº8 SEGURO A BOLITAS (E=21 1 3/8") (D=34.98mm)	HN-N8000/1	
3	HORQUILLA Nº8 SEGURO A BOLITAS (E=6 1 3/4") (D=34.98mm)	HN-N8000/2	
4	HORQUILLA Nº8 SEGURO A BOLITAS (E=20 1 3/4") (D=34.98mm)	HN-N8000/3	
5	HORQUILLA Nº8 P/CAÑO CUAD. HEMBRA C/PROT. (D1=34.98mm) (D2=58.3mm)	HN-N8001	
5	HORQUILLA Nº8 P/CAÑO CUAD. MACHO C/PROT. (D1=34.98mm) (D2=51.5mm)	HN-N8002	

EJES, MAZAS Y PUNTAS DE EJE



- EJES TUBULARES
- EJES CON SUSPENSIÓN
- MAZAS Y PUNTAS DE EJES



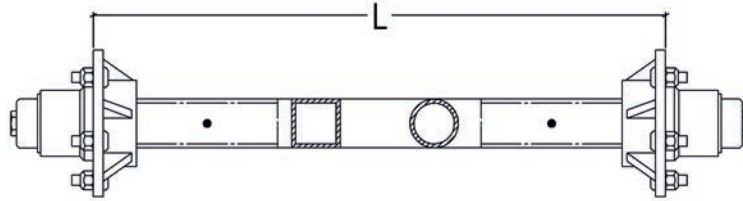

FIG. 1

EJES CON TUBO

FIG.	DESCRIPCIÓN	CÓDIGO	PRECIO
1	EJE C/ROD. 5-6 CAÑO REDONDO ESP 3.50 TROCHA (L=1.45 mts)	E-0101	
1	EJE /ROD. 5-6 CAÑO CUADRADO ESP 4.00 TROCHA (L=1.45 mts)	E-0102	
1	EJE C/ROD. 5-6 CAÑO REDONDO ESP 3.50 TROCHA (L=1.65 mts)	E-0103	
1	EJE C/ROD. 5-6 CAÑO CUADRADO ESP 4.00 TROCHA (L=1.65 mts)	E-0104	
1	EJE C/ROD. 5-7 CAÑO REDONDO ESP. 5.54 TROCHA (L=1.45 mts)	E-0201	
1	EJE C/ROD. 5-7 CAÑO CUADRADO ESP. 5.00 TROCHA (L=1.45 mts)	E-0202	
1	EJE C/ROD. 5-7 CAÑO REDONDO ESP. 5.54 TROCHA (L= 1.65 mts)	E-0203	
1	EJE C/ROD. 5.7 CAÑO CUADRADO ESP. 5.00 TROCHA (L= 1.65 mts)	E-0204	
1	EJE C/ROD. 6-8 CAÑO REDONDO ESP. 5.54 TROCHA (L=1.45 mts)	E-0301	
1	EJE C/ROD. 6-8 CAÑO CUADRADO ESP 5.00 TROCHA (L=1.45 mts)	E-0302	
1	EJE C/ROD. 6/8 CAÑO REDONDO ESP 5.54 TROCHA (L=1.65 mts)	E-0303	
1	EJE C/ROD. 6/8 CUADRADO ESP 5.00 TROCHA (L=1.65 mts)	E-0304	
1	EJE C/ROD. 6-9 CAÑO REDONDO ESP 5.00 TROCHA (L=1.45 mts)	E-0401	
1	EJE C/ROD. 6-9 CAÑO CUADRADO ESP 5.50 TROCHA (L=1.45 mts)	E-0402	
1	EJE C/ROD. 6-9 CAÑO REDONDO ESP 5.00 TROCHA (L=1.65 mts)	E-0403	
1	EJE C/ROD. 6-9 CAÑO CUADRADO ESP 5.54 TROCHA (L=1.65 mts)	E-0404	

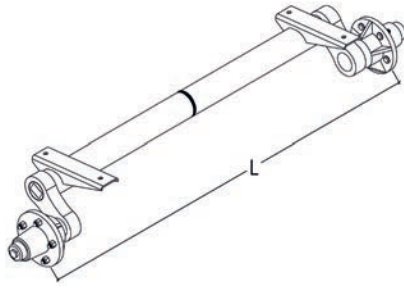

FIG. 1

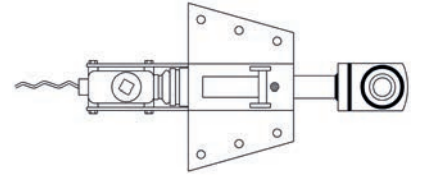

FIG. 2

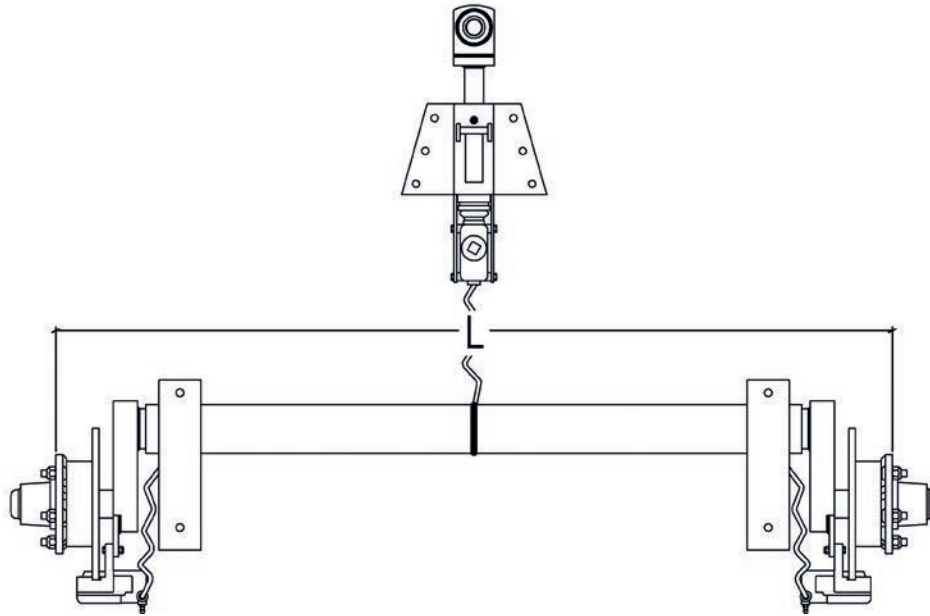

FIG. 3

EJES CON SUSPENSIÓN

FIG.	DESCRIPCIÓN	CÓDIGO	PRECIO
1	EJE CON SUSPENSIÓN 300 KG TROCHA (L=1.45mts) C/MAZA VEHICULAR	ES-3001	
1	EJE CON SUSPENSIÓN 300 KG TROCHA (L=1.65mts) C/MAZA VEHICULAR	ES-3002	
1	EJE CON SUSPENSIÓN 600 KG TROCHA (L=1.45mts) C/MAZA VEHICULAR	ES-6001	
1	EJE CON SUSPENSIÓN 600 KG TROCHA (L=1.65mts) C/MAZA VEHICULAR	ES-6002	
1	EJE CON SUSPENSIÓN 600 KG TROCHA (L=1.45mts) C/MAZA 5-6	ES-6003	
1	EJE CON SUSPENSIÓN 600 KG TROCHA (L=1.65mts) C/MAZA 5-6	ES-6004	
1	EJE CON SUSPENSIÓN 1200 KG TROCHA (L=1.45mts) C/MAZA 5-6	ES-12001	
1	EJE CON SUSPENSIÓN 1200 KG TROCHA (L=1.65mts) C/MAZA 5-6	ES-12002	
1	EJE CON SUSPENSIÓN 1500 KG TROCHA (L=1.45mts) C/MAZA 5-7	ES-15001	
1	EJE CON SUSPENSIÓN 1500 KG TROCHA (L=1.65mts) C/MAZA 5-7	ES-15002	
1	EJE CON SUSPENSIÓN 2000 KG TROCHA (L=1.45mts) C/MAZA 5-7	ES-20001	
1	EJE CON SUSPENSIÓN 2000 KG TROCHA (L=1.65mts) C/MAZA 5-7	ES-20002	
1	EJE CON SUSPENSIÓN 2500 KG TROCHA (L=1.45mts) C/MAZA 6-8	ES-25001	
1	EJE CON SUSPENSIÓN 2500 KG TROCHA (L=1.65mts) C/MAZA 6-8	ES-25002	
1	EJE CON SUSPENSIÓN 3000 KG TROCHA (L=1.45mts) C/MAZA 6-9	ES-30001	
1	EJE CON SUSPENSIÓN 3000 KG TROCHA (L=1.65mts) C/MAZA 6-9	ES-30002	
2	ENGANCHE P/EJE CON SUSPENSIÓN	ESF-10000	
3	EJE CON SUSPENSIÓN 1500 KG TROCHA (L=1.45mts) C/MAZA 5-7 C/FRENO	ESF-15001	
3	EJE CON SUSPENSIÓN 1500 KG TROCHA (L=1.65mts) C/MAZA 5-7 C/FRENO	ESF-15002	
3	EJE CON SUSPENSIÓN 2000 KG TROCHA (L=1.45mts) C/MAZA 5-7 C/FRENO	ESF-20001	
3	EJE CON SUSPENSIÓN 2000 KG TROCHA (L=1.65mts) C/MAZA 5-7 C/FRENO	ESF-20002	

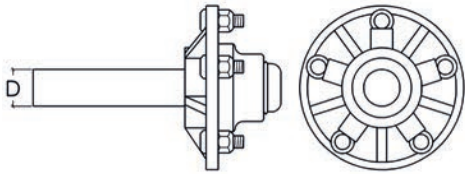

FIG. 1

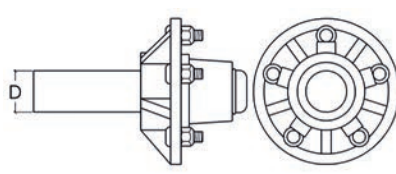

FIG. 2

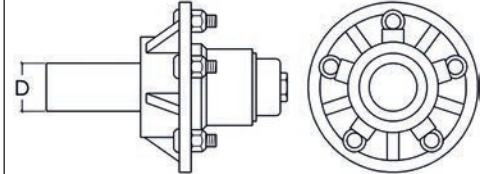

FIG. 3

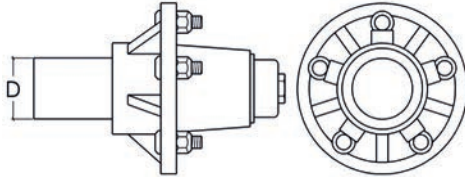

FIG. 4

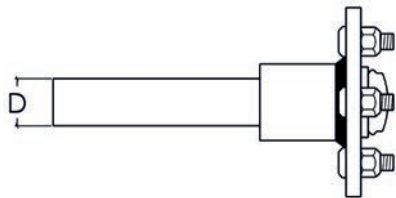

FIG. 5

MAZAS Y PUNTAS DE EJES

FIG.	DESCRIPCIÓN	CÓDIGO	PRECIO
1	MAZA CON RODILLO 5-6 PUNTA DE EJE (D=1 1/2") 5 AGUJEROS	M-100	
2	MAZA CON RODILLO 5-7 PUNTA DE EJE (D=2") 5 AGUJEROS	M-200	
3	MAZA CON RODILLO 6-8 PUNTA DE EJE (D=2") 5 AGUJEROS	M-300	
4	MAZA CON RODILLO 6-9 PUNTA DE EJE (D=2 1/2") 5 AGUJEROS	M-400	
5	MAZA VEHICULAR C/RODILLO 4-5 PUNTA DE EJE (D=1 1/2") 4 AGUJEROS	M-500	

MAZAS PARA ENGRANAGES, RÓTULAS Y PERNOS 3 PUNTOS



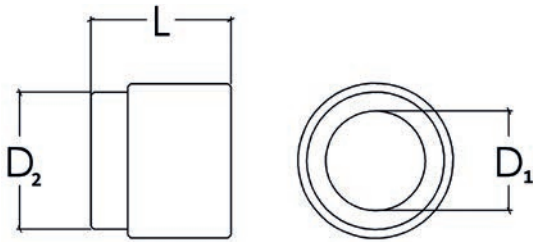

FIG. 1

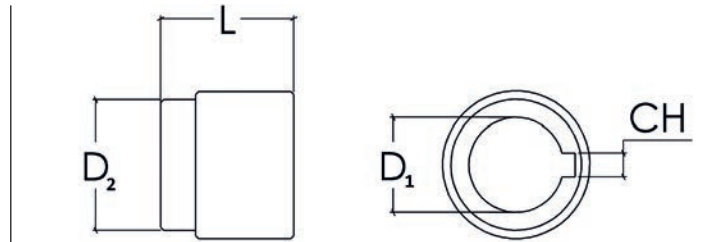

FIG. 2

MAZAS PARA ENGRANAJES

FIG.	DESCRIPCIÓN	CÓDIGO	PRECIO
1	MAZA P/ENGRANAJES (D1=20mm) (D2=35mm) (L=45mm)	ME-1000	
1	MAZA P/ENGRANAJES (D1=22mm) (D2=35mm) (L=45mm)	ME-1001	
1	MAZA P/ENGRANAJES (D1=25mm) (D2=40mm) (L=45mm)	ME-1010	
1	MAZA P/ENGRANAJES (D1=28mm) (D2=45mm) (L=45mm)	ME-1020	
1	MAZA P/ENGRANAJES (D1=30mm) (D2=45mm) (L=45mm)	ME-1030	
1	MAZA P/ENGRANAJES (D1=32mm) (D2=45mm) (L=45mm)	ME-1040	
1	MAZA P/ENGRANAJES (D1=35mm) (D2=50mm) (L=53.5mm)	ME-1050	
1	MAZA P/ENGRANAJES (D1=38mm) (D2=50mm) (L=53mm)	ME-1060	
1	MAZA P/ENGRANAJES (D1=40mm) (D2=55mm) (L=53mm)	ME-1070	
1	MAZA P/ENGRANAJES (D1=45mm) (D2=65mm) (L=53mm)	ME-1080	
1	MAZA P/ENGRANAJES (D1=50mm) (D2=67mm) (L=53mm)	ME-1090	
2	MAZA P/ENGRANAJES (D1=20) (D2=35) (CH=6X3) (L=45mm)	ME-2000	
2	MAZA P/ENGRANAJES (D1=20mm) (D2=40mm) (CH=8X4mm) (L=45mm)	ME-2001	
2	MAZA P/ENGRANAJES (D1=22mm) (D2=35mm) (CH=6X3mm) (L=45mm)	ME-2002	
2	MAZA P/ENGRANAJES (D1=25mm) (D2=40mm) (CH=6X3mm) (L=45mm)	ME-2010/1	
2	MAZA P/ENGRANAJES (D1=25mm) (D2=40mm) (CH=8X4mm) (L=45mm)	ME-2010	
2	MAZA P/ENGRANAJES (D1=28mm) (D2=45mm) (CH=8X4mm) (L=45mm)	ME-2020	
2	MAZA P/ENGRANAJES (D1=30mm) (D2=45mm) (CH=8X4mm) (L=45mm)	ME-2030	
2	MAZA P/ENGRANAJES (D1=32mm) (D2=45mm) (CH=8X4mm) (L=45mm)	ME-2040	
2	MAZA P/ENGRANAJES (D1=35mm) (D2=50mm) (CH=8X4mm) (L=53.5mm)	ME-2050	
2	MAZA P/ENGRANAJES (D1=35mm) (D2=50mm) (CH=10X5mm) (L=53.5mm)	ME-2050/1	
2	MAZA P/ENGRANAJES (D1=38mm) (D2=50mm) (CH=8X4mm) (L=53mm)	ME-2060	
2	MAZA P/ENGRANAJES (D1=40mm) (D2=55mm) (CH=8X4mm) (L=53mm)	ME-2070	
2	MAZA P/ENGRANAJES (D1=40mm) (D2=55mm) (CH=10X5mm) (L=53mm)	M-2070/1	
2	MAZA P/ENGRANAJES (D1=45mm) (D2=65mm) (CH=8X4mm) (L=53mm)	ME-2080	
2	MAZA P/ENGRANAJES (D1=45mm) (D2=65mm) (CH=10X5mm) (L=53mm)	ME-2080/1	
2	MAZA P/ENGRANAJES (D1=50mm) (D2=67mm) (CH=10X5mm) (L=53mm)	ME-2090	

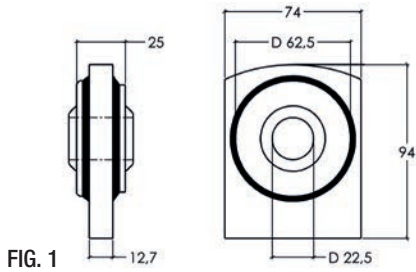

FIG. 1

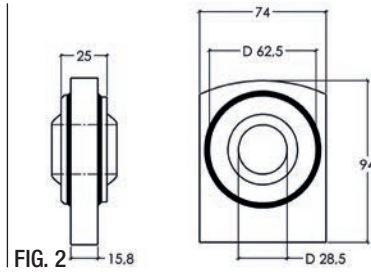

FIG. 2

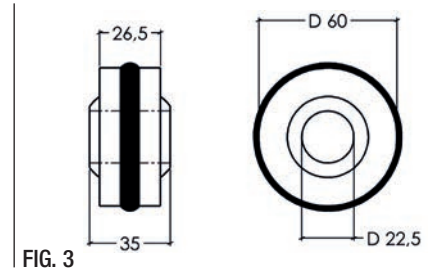

FIG. 3

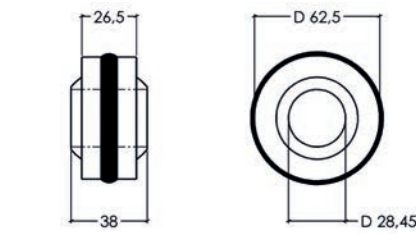

FIG. 4

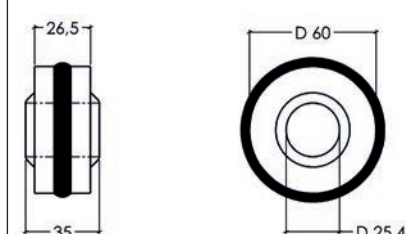

FIG. 5

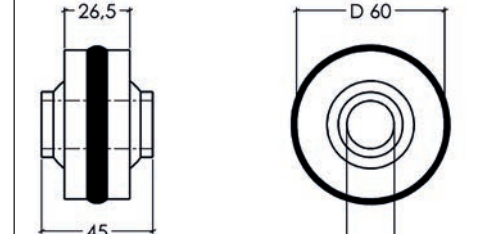

FIG. 6

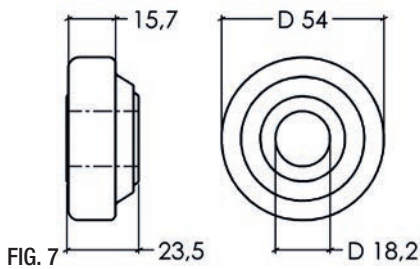

FIG. 7

RÓTULAS

FIG.	DESCRIPCIÓN	CÓDIGO	PRECIO
1	RÓTULAS Nº12 C/TRAT. TÉRMICO	Nº12-T	
1	RÓTULAS Nº12 S/TRAT. TÉRMICO	N112	
2	RÓTULAS Nº13 C/TRAT. TÉRMICO	Nº13-T	
2	RÓTULAS Nº13 S/TRAT. TÉRMICO	Nº13	
3	RÓTULAS Nº14 C/TRAT. TÉRMICO	Nº14-T	
3	RÓTULAS Nº14 S/TRAT. TÉRMICO	Nº14	
4	RÓTULAS Nº15 C/TRAT. TÉRMICO	Nº15-T	
4	RÓTULAS Nº15 S/TRAT. TÉRMICO	Nº15	
5	RÓTULAS Nº16 C/TRAT. TÉRMICO	Nº16-T	
5	RÓTULAS Nº16 S/TRAT. TÉRMICO	Nº16	
6	RÓTULAS Nº17 C/TRAT. TÉRMICO	Nº17-T	
6	RÓTULAS Nº17 S/TRAT. TÉRMICO	Nº17	
7	RÓTULAS Nº18 C/TRAT. TÉRMICO	Nº18-T	

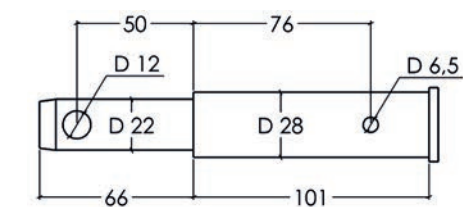

FIG. 1

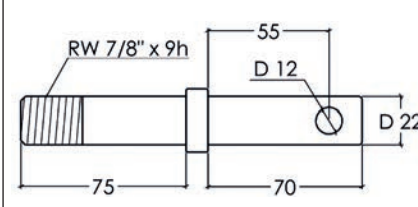

FIG. 2

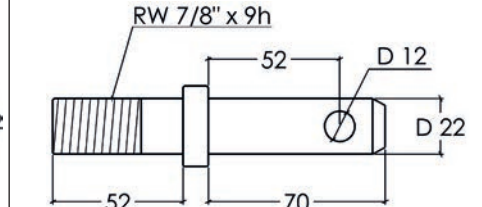

FIG. 3

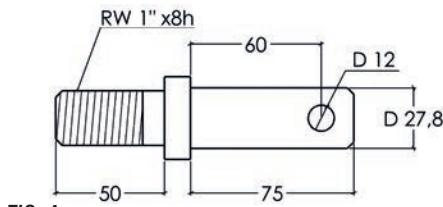

FIG. 4

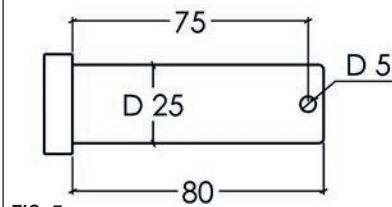

FIG. 5

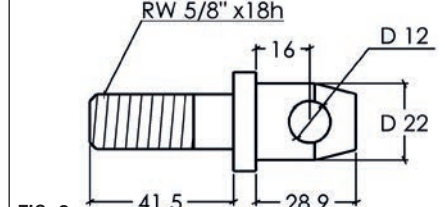

FIG. 6

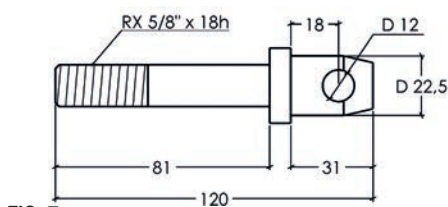

FIG. 7

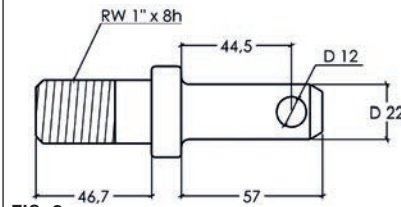

FIG. 8

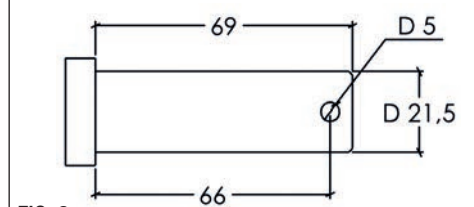

FIG. 9

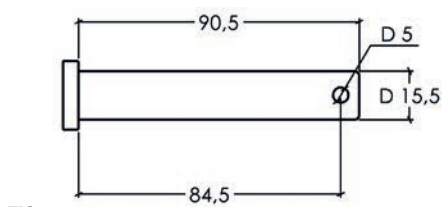

FIG. 10

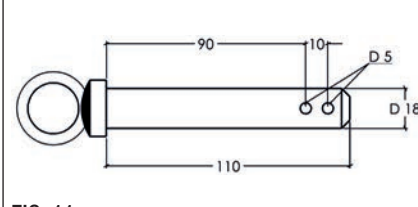

FIG. 11

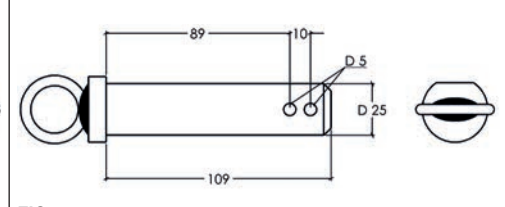

FIG. 12

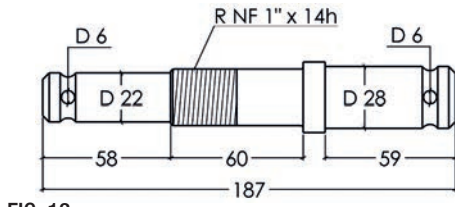

FIG. 13

PERNOS 3 PUNTOS

FIG.	DESCRIPCIÓN	CÓDIGO	PRECIO
1	PERNO PARA ENGANCHE 3 PUNTOS Nº1	Nº1	
2	PERNO PARA ENGANCHE 3 PUNTOS Nº2	Nº2	
3	PERNO PARA ENGANCHE 3 PUNTOS R022	R022	
4	PERNO PARA ENGANCHE 3 PUNTOS R023	R023	
5	PERNO PARA ENGANCHE 3 PUNTOS R079	R079	
6	PERNO PARA ENGANCHE 3 PUNTOS R040	R040	
7	PERNO PARA ENGANCHE 3 PUNTOS R041	R041	
8	PERNO PARA ENGANCHE 3 PUNTOS R069	R069	
9	PERNO PARA ENGANCHE 3 PUNTOS R080	R080	
10	PERNO PARA ENGANCHE 3 PUNTOS R081	R081	
11	PERNO PARA ENGANCHE 3 PUNTOS R082	R082	
12	PERNO PARA ENGANCHE 3 PUNTOS R082-A	R082-A	
13	PERNO PARA ENGANCHE 3 PUNTOS R087	R087	

www.edma.com.ar

Contactanos al:

+54 03472 424849 / 249

Horarios de atención:

Lunes a Viernes de 8:00 a 12:00 hs y de 14:30 a 18:30 hs. Sábados de 8:00 a 12:00 hs.